



COMPLETE
SYSTEM

SCHIEDEL

UK Plus Flue System

A modular, high quality stainless steel concentric flue system for balanced flue applications.





Schiedel UK Plus

OUTSTANDING STEEL STYLE AND PERFORMANCE

Schiedel is a leading supplier of prefabricated chimney systems in Europe with the widest choice of chimney and flue products. Schiedel is at the forefront in product and service innovation, with systems and solutions that are reliable, innovative and cost-effective.

Our products conform to the most stringent standards of design, manufacture and performance required world-wide, and are CE certified in accordance with EN 1856-1 and EN1856-2 and manufactured under BS EN ISO 9001-2000 quality control systems.

Schiedel always strives to deliver the highest quality to the customers all over the world – the highest quality products, an outstanding engineering and excellent service – in short, an unparalleled experience for our customers. The foundation is our deep-rooted, technical in-house know-how, accumulated over decades and the fact that more than 90% of our production is produced in-house at our European plants. All Schiedel products are certified to European and local standards.

System overview

Product description	UK Plus is a modular, high quality stainless steel concentric flue system for balanced flue applications. It is designed to operate with room sealed condensing or non-condensing gas or oil appliances in positive or negative pressure with continuous operating temperature up to 200 °C. without the seal it can be used on gas fires with a temperature rating of up to T600.
Installation	Outside or inside a building
Fuels	Gas and Oil
Operating temperature	≤ 200 °C with seal < 600 °C without seal
Mode of operation	- Negative pressure (N1 ≤ 40 Pa) - Positive pressure (P1 ≤ 200 Pa) with silicone lip seal gaskets - Wet / Dry
Inner pipe material	EN 1.4404 (AISI 316L), 0,4 mm thickness
Outer case material	EN 1.4301 (AISI 304), 0,4 mm thickness
Outer case finish	- BA (bright annealed) - Painted white
Connection	Push fit system, elements secured by locking band
Diameters	80/130, 100/150, 130/200

EN 1856-1 System chimney:	036 – CPR – 91236-057
CE Designation:	T200 - P1 - W - V2 - L50040 – O00 T200 - P1 - W - Vm - L50040 - O00. T600 - N1 - W - V2 - L50040 – O50 T600 - N1 - W - Vm - L50040 – O50

EN 1856-2 Connecting flue pipe:	0036 – CPR – 91236-058
CE Designation:	T200 - P1 - W - V2 - L50040 – O30 T200 - P1 - W - Vm - L50040 – O30

System properties:

- Multi purpose concentric system in lightweight design
- Suitable for internal and external application
- Silicone gaskets ensure P1 pressure tightness
- With viton gaskets suitable also for oil appliances
- High quality engineered joints secured by locking bands
- Wide range of installer friendly accessories
- No thermal bridges

Application area:

- Flue gas extraction and air supply of room-sealed appliances
- Condensing appliances
- Residential or commercial use



Design guide

Mandatory requirements

The system must be installed according to European Norms, national building regulations and instructions of the manufacturer as indicated in the documentation. Apart from the general instructions there are specific instructions in connection with the type of connected gas appliance. Always refer to installation instructions of the boiler manufacturer for details. Special attention should be drawn to max. permitted pipe length of the flue system (can be found in appliance installation manual). In some cases a special appliance adaptor should be used to connect the appliance with UK Plus flue system.

The connection to the appliance may be carried out only by a competent person. Connection to an appliance that is connected to the fuel supply must be carried out by a Gas Safe (Gas) or OFTEC (Oil) registered installer.

Flue diameter

The chimney size should be as recommended by the appliance manufacturer. The operational requirements of the appliance and the configuration of the flue must satisfy the flue sizing requirements of EN13384-1.

Flue route

The flue should remain as straight as possible through its entire length to assist flow. Bear in mind that each tight bend reduces max. permitted pipe length.

Distance to combustibles

In accordance with building regulations, it is essential that the correct distance to combustible material is maintained. UK Plus is suitable for use with low temperature or condensing gas and oil appliances with flue gas temperatures $< 200^{\circ}\text{C}$. Where used as a System Chimney at low temperature, the system may be installed with 0mm distance to combustibles.

Where the system is being used in the horizontal at low temperature, $< 200^{\circ}\text{C}$, then a distance to combustibles of 30mm is required.

Where used on a high temperature application where flue gases could be up to 600°C , then a distance to combustibles of 50mm is required. In this application the chimney must be fully ventilated.

Enclosure/Shafts

With the exception of the room containing the appliance, where the chimney passes through any part of the building, where there is a risk of accidental human contact, i.e. a bedroom etc., or where there is a risk of contact with combustible materials, the chimney must be enclosed in an appropriate way to meet Building regulations. The minimum distance to any combustible material, including loft insulation, must be respected.

Inspection

According to national regulation, provisions should be made to enable easy access for inspection and cleaning. Respective national building code and requirements of appropriate standards should be observed. We recommend to consult competent chimney sweeper on the arrangement of the inspection openings.

Provision for Condensate Disposal (subject to appliance manufacturer recommendations)

Condensing appliances need provision for drainage. Choose appropriate flue drainage components, normally fitted at the base of the stack and close to the appliance outlet. A 3° slope (5 cm/m) from vertical run towards the appliance must be maintained, using the appropriate 87° bend and 87° tee.

On longer horizontal runs there might be additional supports required to support the flue in order to maintain the required slope.



Design guide

Load bearing information

A	Max. installation height from base or intermediate support	30 m
B	Max. distance between lateral supports	4 m
C	Max height above last support	3 m

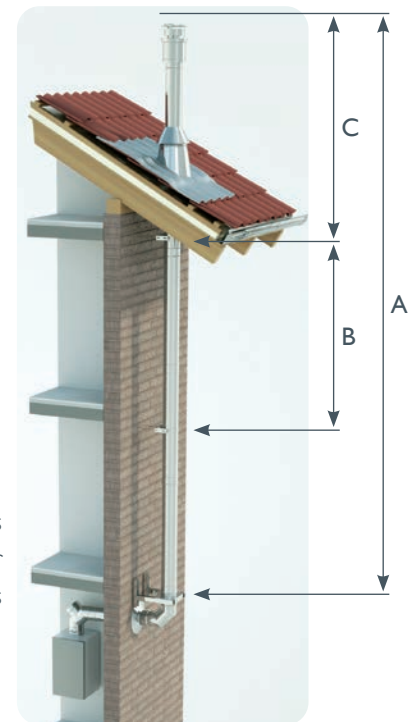

Appliance/Chimney Connection

Connection to the appliance should be done by using appropriate appliance connector.

Requirements on location of flue/gas system termination

Flue termination for gas appliances are subject to EN 15287-1. Annex M gives recommendations for the most common siting situations encountered. Adjacent taller structures and roof windows may require increased height. Please refer also to requirements on air/flue pipe outlet specified in installation instructions of the connected appliance.

Lightning protection

Stainless steel flue gas system can be damaged by a lightning strike. If a building has a lightning conductor circuit make sure that flue gas system is linked to it.

Support Components

The weight of a chimney system requires independent support. Minimal weight should be borne by the appliance. The weight of the chimney can be supported from floor level by using a base support plate, or floor support; from the wall by using wall support top plates together with side plates or cantilever brackets; or from first floor level by using a support plate fixed to the floor/ceiling joists.

Wall brackets are non load bearing and provide lateral support only. Refer to the load bearing tables for full details of maximum loadings.

Free standing height above the roof

Where the flue is freestanding above the roof and its height exceeds 1.5 m above the last support or above the roof, a guy wire bracket must be used and every 1.5 m thereafter in conjunction with guy wires or rigid stays (provided by others). Alternatively a height of up to 3 m can be achieved unsupported using extended locking bands at the joint immediately below the last support and on every joint above it.

CE data plate

After installation a chimney plate must be applied. This is the responsibility of the installer.



Installation instructions

Installation – which way up?

All flue gas carrying components must be installed with the direction arrow on the product label pointing to termination with the external male spigot of the case uppermost.

Joining System

All joints in the UK Plus chimney range are made by means of a simple push fit joining method. This is achieved by the engineered spigot and socket system having a pronounced lead-in-edge to ease assembly. When installing UK Plus components, Gaskets should be fitted dry and lubricant applied to the external of the male liner spigot. All pipes, tees, wall support top plate and terminals are supplied with a standard locking band.

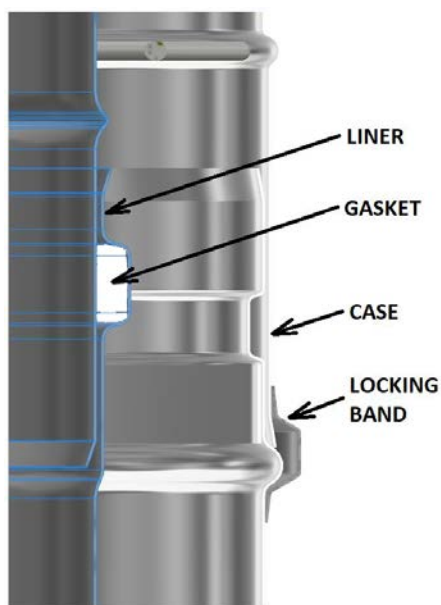

Thermal expansion

All UK Plus elements are designed to allow for thermal expansion of the liner within each joint, so there is no requirement for any additional expansion joints when using the UK Plus System.

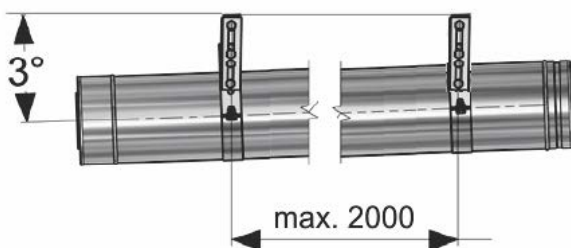

Horizontal installation

When UK Plus is installed in horizontal runs, pipe elements should be supported every 2 m to prevent sag and maintain a 3° slope for condensate disposal.

Installation examples

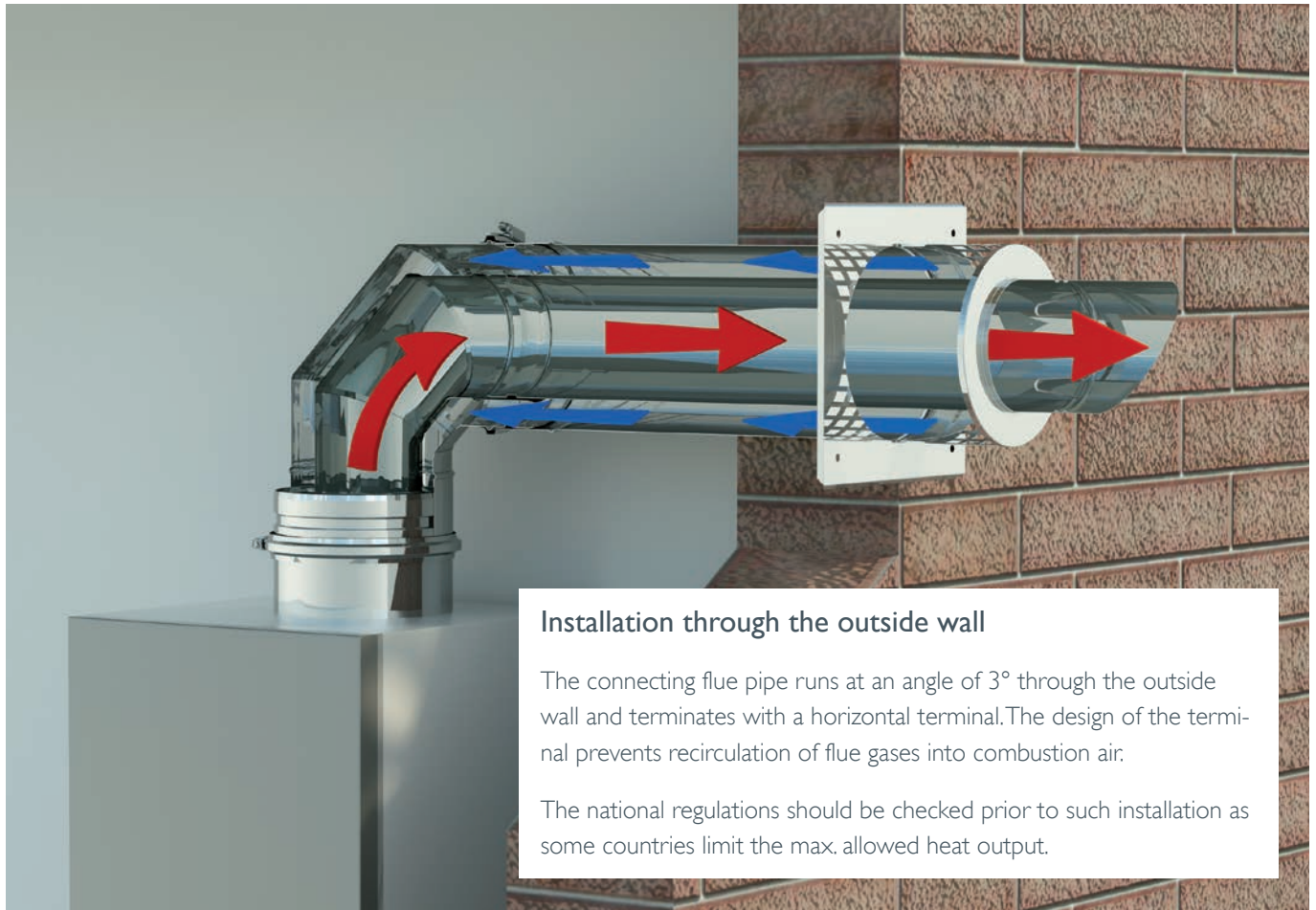

Installation on the outside wall

The connecting flue pipe runs at an angle of 3° through the outside wall with transition into the vertical run through an 87° bend.

The vertical section of the flue is supported with a top plate installed immediately above the bend and additionally secured with cantilever brackets. An offset can be included into vertical run to avoid penetration through the roof.



System components

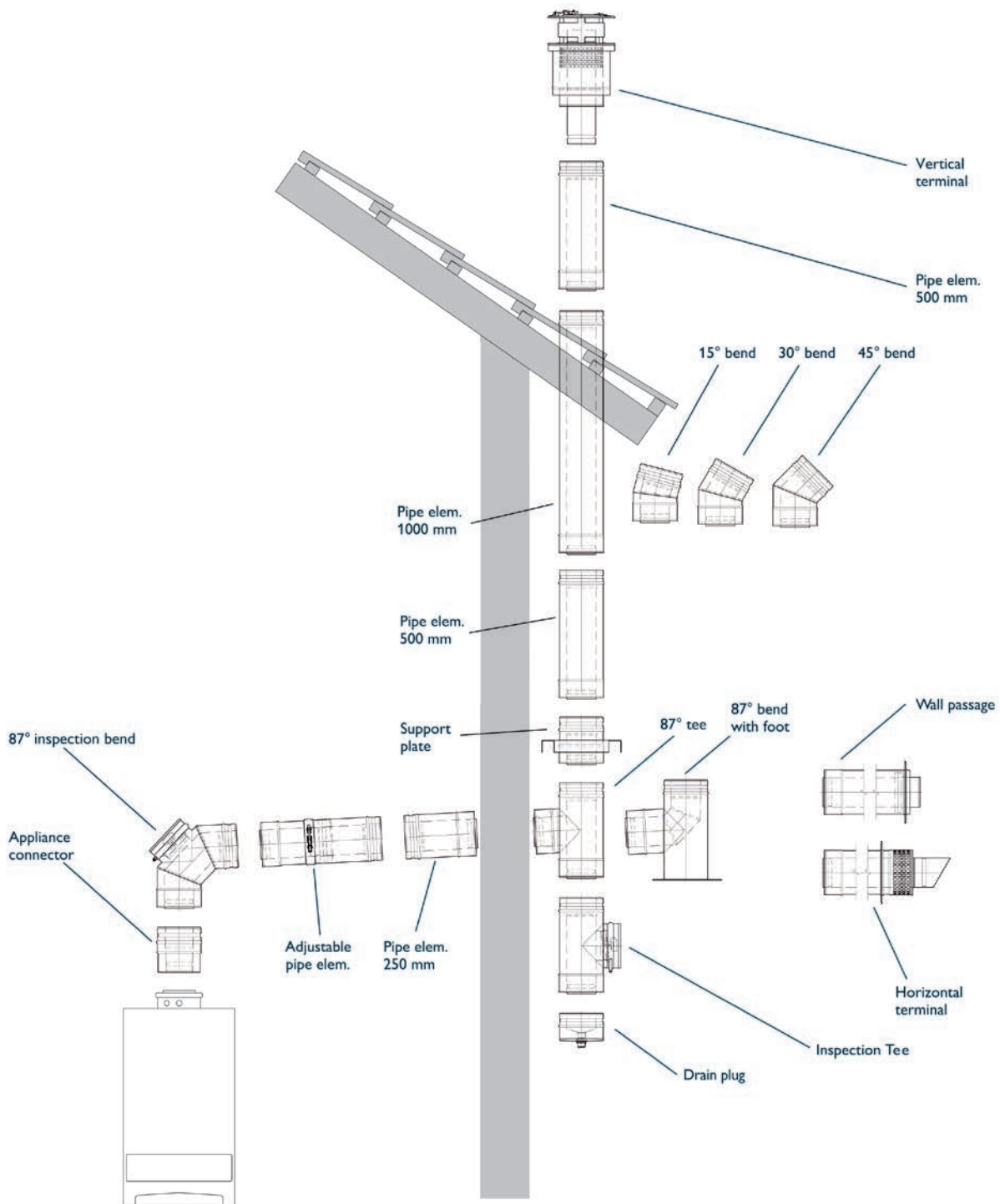

Starting components

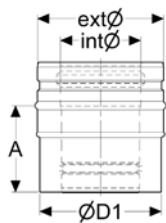

Appliance connector

Int Ømm	80	100	130
Ext Ømm	130	150	200
A	90	99	99
ØD1	126	148	198
kg	0.34	0.38	0.51
SAP	173981	174387	174388

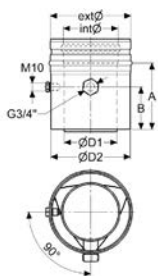

Appliance connector with test point

Int Ømm	80	100	130
Ext Ømm	130	150	200
A	125	125	125
B	80	80	80
ØD1	79	99	129
ØD2	124	149	199
Weight (kg)	0.52	0.60	0.75
SAP	174370	174382	174117

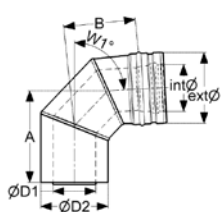

87° Appliance connector

Int Ømm	80		
Ext Ømm	130		
A	165		
B	125		
W1°	87		
ØD1	79		
ØD2	124		
SAP Code	174116		

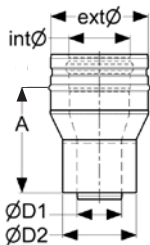

Increaser

Int Ømm	80	100
Ext Ømm	130	150
A	141	141
ØD1	60	80
ØD2	99	129
SAP Code	174378	174371

Starting components

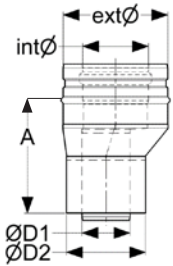

Excentric increasing appliance connector

Int Ømm	80	100
Ext Ømm	130	150
A	141	130
ØD1	59	80
ØD2	99	129
Weight (kg)	0.42	0.516
SAP	174379	174380

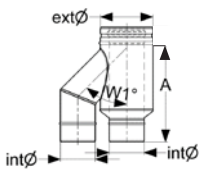

Trouser section

Int Ømm	80	100
Ext Ømm	130	150
A	290	288
W1°	45	45
Weight (kg)	0.716	1.011
SAP	174369	174381

Gaskets / Locking bands



Silicon Gasket (Gas Only)

Int Ømm	80	100	130
Ext Ømm	130	150	200
SAP	900012446	900012447	900012449



Viton Gasket (Gas & Oil)

Int Ømm	80	100	130
Ext Ømm	130	150	200
SAP	160574	160575	160576

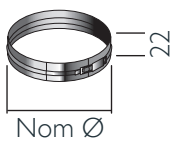

Locking Band

Int Ømm	80	100	130
Ext Ømm	130	150	200
SAP	144485	144486	144488

Pipes

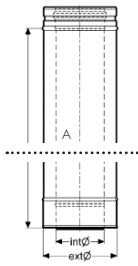

950mm Pipe

Int Ømm	80	100	130
Ext Ømm	130	150	200
A	950	950	950
Weight (kg)	2.177	2.589	3.414
SAP	173920	173924	173928

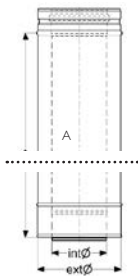

445mm Pipe

Int Ømm	80	100	130
Ext Ømm	130	150	200
A	445	445	445
Weight (kg)	1.113	1.322	1.743
SAP	173921	173925	173929

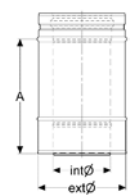

200mm Pipe

Int Ømm	80	100	130
Ext Ømm	130	150	200
A	200	200	200
Weight (kg)	0.587	0.695	0.916
SAP	173922	173926	173930

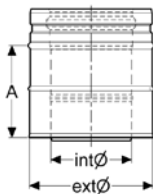

115mm Pipe

Int Ømm	80	100	130
Ext Ømm	130	150	200
A	115	115	115
Weight (kg)	0.407	0.482	0.482
SAP	173923	173927	173927

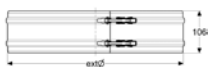

Structural locking band

Int Ømm	80	100	130
Ext Ømm	130	150	200
SAP	101124	101125	101127

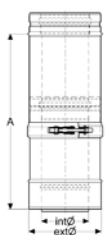

Adjustable pipe section pipe 285-370

Int Ømm	80	100	130
Ext Ømm	130	150	200
A	285-370	285-370	285-370
Weight (kg)	1.267	1.493	1.952
SAP	173955	173956	173957

Pipes

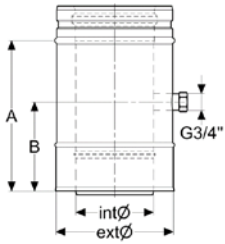

Pipe with test point

Int Ømm	80	100	130
Ext Ømm	130	150	200
A	196	196	196
B	116	116	116
Weight (kg)	0.653	0.762	0.993
SAP	173985	173986	173987

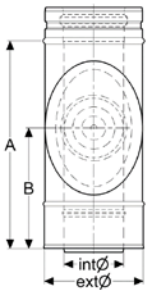

Inspection pipe

Int Ømm	80	100
Ext Ømm	130	150
A	281	281
B	164	164
Weight (kg)	1.043	1.280
SAP	174373	174383

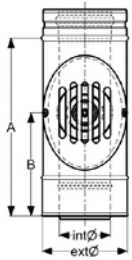

Inspection pipe with air intake

Int Ømm	80	100
Ext Ømm	130	150
A	281	281
B	164	164
Weight (kg)	0.943	1.185
SAP	174374	174386

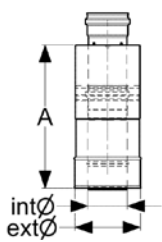

Adjustable pipe with air intake

Int Ømm	80
Ext Ømm	130
A	215-310
Weight (kg)	0.900
SAP	174372



Wall pass through

Int Ømm	80	100	130
Ext Ømm	130	150	200
A	410	410	410
Weight (kg)	1.185	1.404	1.854
SAP	173982	173983	173984

Bends

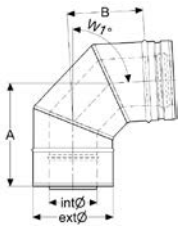

87° Bend

Int Ømm	80	100	130
Ext Ømm	130	150	200
A	170	175	205
B	120	125	155
W1°	87	87	87
Weight (kg)	0.715	0.878	1.313
SAP	173943	173944	173945

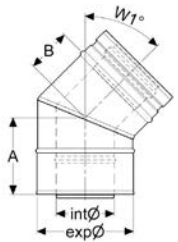

45° Bend

Int Ømm	80	100	130
Ext Ømm	130	150	200
A	105	110	115
B	55	65	75
W1°	45	45	45
Weight (kg)	0.509	0.631	0.881
SAP	173940	173941	173942

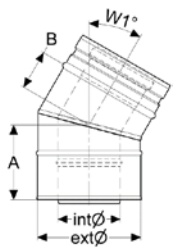

30° Bend

Int Ømm	80	100	130
Ext Ømm	130	150	200
A	95	100	110
B	50	55	65
W1°	30	30	30
Weight (kg)	0.470	0.581	0.815
SAP	173937	173938	173939

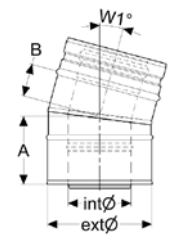

15° Bend

Int Ømm	80	100	130
Ext Ømm	130	150	200
A	87	91	93
B	42	46	48
W1°	15	15	15
Weight (kg)	0.429	0.528	0.708
SAP	173934	173935	173936

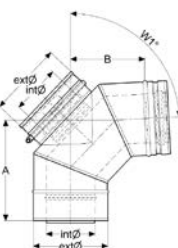

87° Inspection bend

Int Ømm	80	100	130
Ext Ømm	130	150	200
A	190	205	265
B	145	160	220
W1°	87	87	87
Weight (kg)	1.233	1.535	2.977
SAP	173977	173978	173980

Bends / Tees

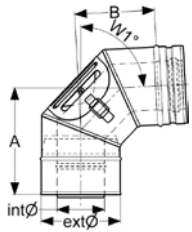

87° Bend with air intake

Int Ømm	80	100
Ext Ømm	130	150
A	175	175
B	125	125
W1°	87	87
Weight (kg)	0.815	0.980
SAP	174375	174384

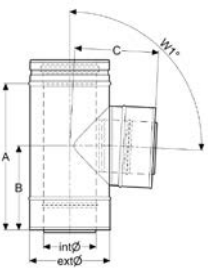

87° Tee

Int Ømm	80	100	130
Ext Ømm	130	150	200
A	280	280	450
B	165	165	250
C	150	160	185
W1°	87	87	87
Weight (kg)	0.933	1.088	1.989
SAP	173967	173968	173969

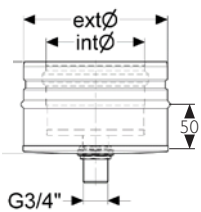

Drain plug

Int Ømm	80	100	130
Ext Ømm	130	150	200
Weight (kg)	0.933	1.088	1.989
SAP	173958	173959	173960

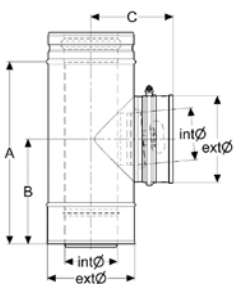

Inspection tee

Int Ømm	80	100	130
Ext Ømm	130	150	200
A	279	279	446
B	161	161	244
C	125	135	160
Weight (kg)	1.151	1.140	2.489
SAP	173952	173953	173954

Support components

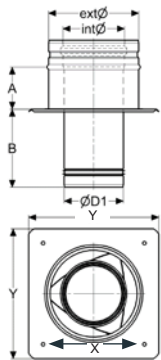

Anchor plate / Extension Support

Int Ømm	80	100	130
Ext Ømm	130	150	200
A	71	71	71
B	130	130	130
D1	79	99	129
X	150	170	220
Y	200	220	270
SAP	173991	173992	173993

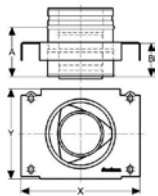

Top plate

Int Ømm	80	100	130
Ext Ømm	130	150	200
A	100	100	100
B	63	63	63
X	255	275	325
Y	188	208	258
SAP	173949	173950	173951

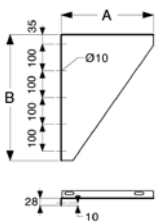

Side plates

Int Ømm	80	100	130
Ext Ømm	130	150	200
A	220	240	290
B	470	470	470
Weight (kg)	2,2	2,4	3,2
SAP	101042	101043	101045

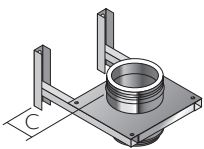

Cantilever Support Adjustment



Cantilever Brackets - Types 325, 475

Cantilever supports

Int Ømm	80/130	100/150	150/200
	'C' Min/Max (mm)		
Type 325	50/184	50/164	50/114
Type 475	50/334	50/314	50/264
Weight (kg)	2,4	3,0	-
SAP	101742	101743	

Support components

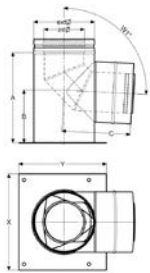

87° Tee with foot

Int Ømm	80	100	130
Ext Ømm	130	150	200
A	301	301	301
B	176	176	176
C	225	225	225
W1°	93	93	93
X	250	270	320
Y	220	240	290
Weight (kg)	1.737	2.019	2.745
SAP	173970	173971	173972

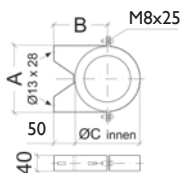

Wall band

Int Ømm	80	100	130
Ext Ømm	130	150	200
A	138	158	208
B	116	126	151
C	131	151	201
SAP	101263	101264	101266

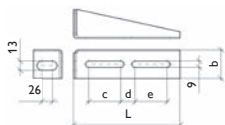

Wall band extension Type W1

L	130
c	50
d	16
e	35
Weight (kg)	0.3
SAP	101735

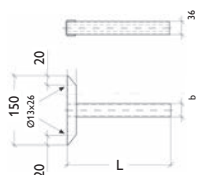

Wall band extension Type L1

Type	L1	L2	L3
L	300	450	550
b	32	32	42
Weight (kg)	1.7	2.2	2.6
SAP	101738	101739	101740

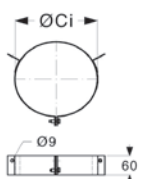

Guy wire bracket

Int Ømm	80	100	130
Ext Ømm	130	150	200
C	130	150	200
Weight (kg)	0,44	0,47	0,54
SAP	100639	100640	100642

Flashings / Collars

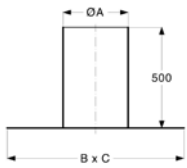

Flat flashing			
Int Ømm	80	100	130
Ext Ømm	130	150	200
A	200	200	250
B x C	700	700	750
SAP	101226	101226	101227

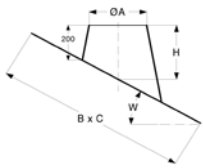

Wakaflex Black Flashing 3°-15°			
Int Ømm	80	100	130
Ext Ømm	130	150	200
ØA	200	200	250
B x C	689x685	689x685	742x735
H	257	257	266
SAP Black Cone	148967	148967	148968
SAP Matt Steel	175252	175252	175253

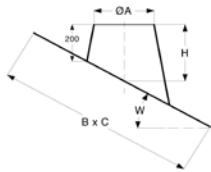

Wakaflex Black Flashing 16°-25°			
Int Ømm	80	100	130
Ext Ømm	130	150	200
ØA	200	200	250
B x C	713x693	713x693	770x745
H	313	313	332
SAP Black Cone	148985	148985	148986
SAP Matt Cone	175261	175261	175262

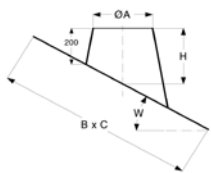

Wakaflex Black Flashing 26°-35°			
Int Ømm	80	100	130
Ext Ømm	130	150	200
ØA	200	200	250
B x C	754x703	754x708	818x758
H	381	381	414
SAP Black Cone	149003	149003	149004
SAP Matt Cone	175270	175270	175271

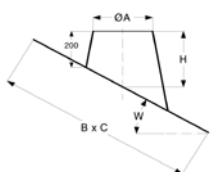

Wakaflex Black Flashing 36°-45°			
Int Ømm	80	100	130
Ext Ømm	130	150	200
ØA	200	200	250
B x C	821x715	821x715	897x793
H	474	474	523
SAP Black Cone	149021	149021	149022
SAP Matt Cone	175279	175279	175280

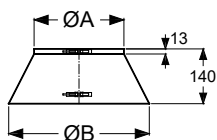

Storm collar			
Int Ømm	80	100	130
Ext Ømm	130	150	200
ØA	130	150	200
ØB	270	290	340
Weight (kg)	0.29	0.51	0.38
SAP	100969	100970	100642

Terminal

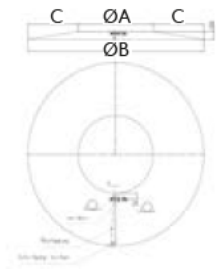

Trim collar

Int Ømm	80	100	130
Ext Ømm	130	150	200
A	135	155	205
B	405	425	475
C	135	135	135
Weight (kg)	0,54	0,59	0,74
SAP	104505	104506	104508

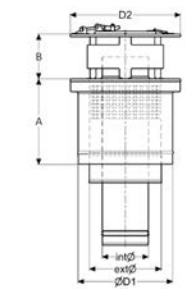

Terminal vertical

Int Ømm	80	100	130
Ext Ømm	130	150	200
ØD1	180	200	270
ØD2	203	233	273
A	220	220	220
B	95	95	130
Weight (kg)	1.536	1.818	2.338
SAP	173961	173962	173963



Terminal horizontal

Int Ømm	80	100	130
Ext Ømm	130	150	200
A	390	390	390
B	620	630	640
Weight (kg)	1.306	1.557	2.064
SAP	173964	173965	173966

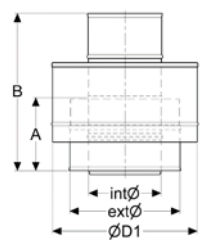

Air terminal

Int Ømm	80	100	130
Ext Ømm	130	150	200
A	100	100	100
B	225	225	225
ØD1	180	200	270
Weight (kg)	0.680	0.795	1.118
SAP	173988	173989	173990

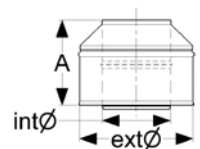

Top stub

Int Ømm	80	100
Ext Ømm	130	150
A	100	100
Weight (kg)	0.273	0.295
SAP	174376	174118

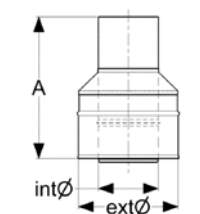

Top stub air

Int Ømm	80	100
Ext Ømm	130	150
A	195	195
Weight (kg)	0.328	0.395
SAP	174377	174385

Schiedel

WE HAVE THE COMPLETE SERVICE

Whether it's a biomass flue solution, a multi-flue chimney, a fan dilution system or a generator exhaust, we have a product to suit every commercial or industrial application.

We offer the full engineering and technical support. Both in the private and public-sector Schiedel has unrivalled experience that you can rely on whatever the scale or nature of your project is – from chimneys to exhaust and venting systems.

Schiedel is well-known for collaborating closely with customers. We always offer our customers the best possible service. On-site, our technical team can provide site analysis and application advice as required. We can design and manufacture for projects in Europe and all over the world, and arrange for on-site installation from a small commercial installation to a large industrial application.

SCHIEDEL INSTALLER REWARDS



LOVE2SHOP

Exciting news from Schiedel Chimney Systems for Stove and Chimney Installers!

Whenever you register an installation with our easy to use, online guarantee registration portal, you will now accrue points based on the number of installations and installation type.

Once you have reached a minimum of 25 points, you can begin to redeem them for £25 Love2Shop vouchers.

So head on over to the portal and start to register your installations to take full advantage of our Lifetime Guarantee on ICID, and also to start earning points!

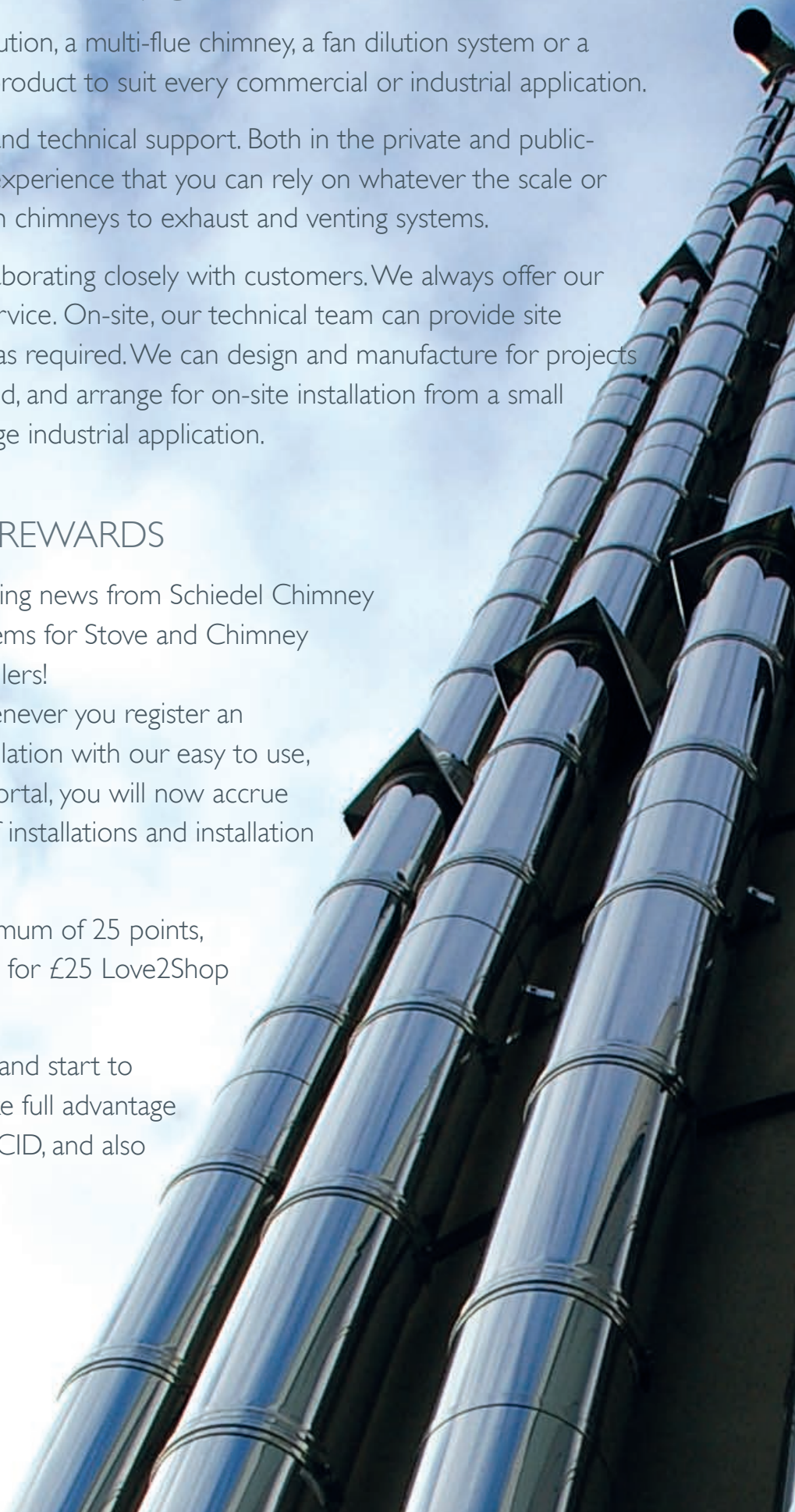



Top level services

Site survey
System selection for optimum cost and performance
System sizing
Design and layout drawings
On-site installation
Ongoing technical support including facilities management

TYPICAL APPLICATIONS

CHIMNEY SYSTEMS

Fluing systems for biomass, gas and oil boilers
Natural draught
Fan assisted/positive pressure
Fan dilution
Condensing
Modular header

EXHAUST SYSTEMS

Generators, turbines, CHP

OTHER VENTING SYSTEMS

Process plant
Bakery ovens
Smoke extraction
Passive ventilation
Fire rated service duct, cable duct
Rubbish chutes

SUPPORT SYSTEMS

Building supported, internal, external
Mast supported, free standing single/multi-leg
Windshield
Relining existing stack

The spark in all of us

The spark in all of us is an internal north star and constant driver of all our ideas and actions. An irrepressible force of nature that constantly pushes us forward and helps us to leave old things behind.

It is the source of our inspiration to make things better, smarter, more sustainable and stay ahead of the game. The spark of our inspiration also jumps over to the people we deal with: our partners, our customers.

THE SPARK

STANDARD-SETTER

We spark tomorrow's industry standards & trends.

PASSIONATE

New ideas for future buildings are constantly sparked by our ingrained passion for smarter, more liveable, sustainable solutions.

CARING

We value and nurture the spark that our people carry and how they transfer it over to our customers.

PARTNERSHIP-ORIENTED

We pro-actively seek our customers feedback to let their needs spark inspiration for new technical solutions and services.

It is in our DNA to answer important questions: How does a modern chimney or fireplace need to look like, to make people happy? What exactly is it, that "sparks" a home with warmth, inspiration and a feeling of cosiness and independence? To answer these questions, we address relevant future trend topics: families, sustainability, product & design and industry.

THE SPARK is our motto under which we want to shed light on future opportunities and how to actively use them.

Spark up your life

The spark is what drives us at Schiedel, and so, looking ahead, we are proactively facing one question: what will the future hold for us?

Only by understanding the key challenges and their effects on our future lives, Schiedel will be able to continue its standard-setting ambitions.

Discover more about the future trends "family", "sustainability", "product & design" and "industry".

FAMILIES



Spending more time at home is becoming an increasingly desirable goal for many people. Thanks to online shopping and home office,

there are even more reasons to create a beautiful home. At home, families strive for maximum comfort – which leads to high expectations when it comes to aesthetics, functionality and, last but not least, convenience. Furthermore, the seamless integration of products into smart homes and on-demand services is of great importance. We are already trying to meet those requirements and contribute to space saving, cozy homes for today's and future homeowners.

SUSTAINABILITY



At no time it has ever been more important for us at Schiedel to offer customers longterm solutions based

on sustainability. Both, you as a customer as well as we as a company want to proactively change the world together.

At Schiedel, we care deeply about the environment; we focus on environmentally friendly and energy-efficient, low-energy solutions, like new filters, hybrid vents and thermo block stones. With the UK Plus system, we already provide an energy efficient, and low emission solution.

PRODUCT & DESIGN



On top of products being valuable and useable, we also need to build products and experiences that are enjoyable – focusing on

how the things we have created make people feel. At Schiedel we learn from and grow with our customers. We design and constantly adjust solutions that are based on customer needs, creating product features that exceed existing norms: clear, simple and effective design that radiates peace, improves well-being and saves space. .

INDUSTRY



Climate change and extreme weather phenomena affect industry and economics on many different levels. The number of consci-

ous consumers is growing. We are called upon to take these changes into account when it comes to developing new products as well as innovative services.

On our mission to produce sustainably, we will continue to use and search for renewable resources and look for new ways to reduce waste. Internally, we constantly push towards the future through constantly improving our production setup, BIM Offering and 3D CAD.



SCHIEDEL

Schiedel Chimney Systems
Crowther Estate, Washington
Tyne & Wear NE38 0AQ
Tel. +44 (0)191 416 1150

sales.uk@schiedel.com
schiedel.com/uk

Follow us on Social Media @SchiedelUK



A **standard**
INDUSTRIES COMPANY