

CENIK 2024

Keramični program

SCHIEDEL



Veljavnost cenika od 20. 3. 2024 do preklica.

www.schiedel.si

Kazalo vsebine

SCHIEDEL ABSOLUT	Schiedel ABSOLUT Najsodobnejši dimnik za vse vrste goriv in kotlov. Primeren za vgradnjo v pasivne hiše.	stran 5 - 22
SCHIEDEL UNI ISO PLUS	Schiedel UNI ISO PLUS Univerzalni dimniški sistem z novo isostatično keramično cevjo.	stran 23 - 48
SCHIEDEL FINAL	Schiedel FINAL Montažni zaključek v imitaciji klasične opečne obzidave. Najcenejša izvedba zaščite dimnika nad streho.	stran 49 - 54
SCHIEDEL UNI PLUS	Schiedel UNI PLUS Klasičen dimniški sistem primeren za vse vrste goriv in kotlov.	stran 55 - 86
	Ostali prodajni program	stran 87

→ Schiedel ABSOLUT

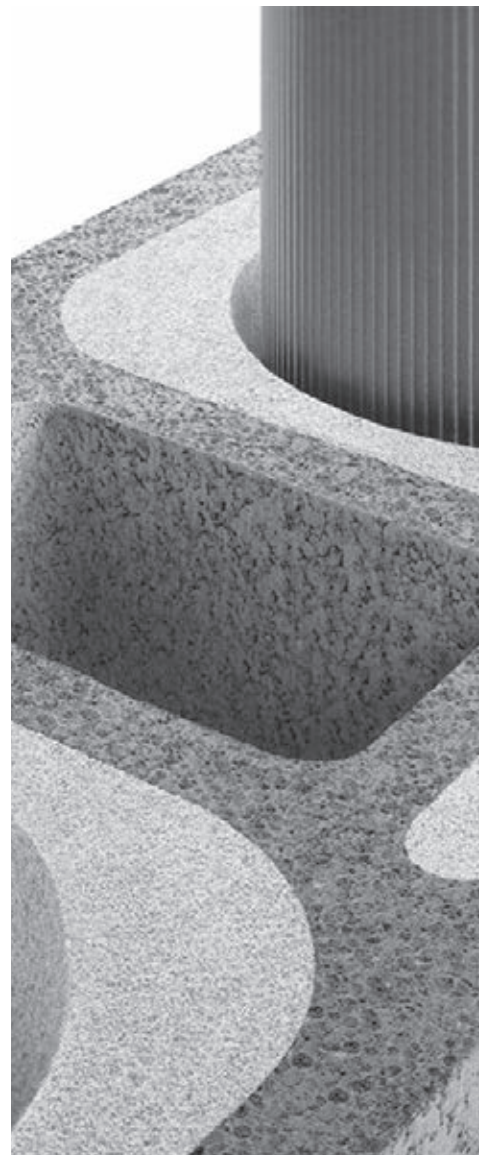

Najsodobnejši dimnik za vse vrste goriv in kotlov.
Primeren za vgradnjo v pasivne hiše.



SCHIEDEL

ABSOLUT

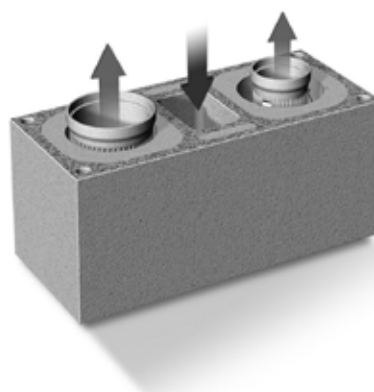

ABSOLUT

Enojni Ø 12 - Ø 25 cm

SCHIEDEL
ABSOLUT

→ Svetli premer dimnika 12 14 16 18 20 25



Dimniški plašč Absolut	12	14	16	18	20	25
3 kosi/m						
SAP	100023	100023	100023	100023	100027	100031
EAN	4037494055052	4037494055052	4037494055052	4037494055052	4037494068960	4037494173404
EUR/kos	23,30	23,30	23,30	23,30	26,20	37,70



Cev Absolut	12-133	14-133	16-133	18-133	20-133	25-66
Dolžina cevi: od Ø 12 - Ø 20 = 133 cm Ø 25 = 66 cm						
SAP	100037	100038	100039	100040	100041	100047
EAN	4037494057407	4037494014875	4037494057414	4037494057421	4037494066645	4037494142882
EUR/kos	76,80	83,80	93,90	115,60	119,80	95,40



Peta dimnika	12-18	12-18	12-18	12-18	20	*25
Višina 107 cm						
SAP	143802	143802	143802	143802	143804	100133
EAN	4051921643223	4051921643223	4051921643223	4051921643223	4051921643247	4037494183403
EUR/kos	490,50	490,50	490,50	490,50	634,60	421,30

+

*ABS Osnovni paket 25



Paket pete dimnika Absolut	12	14	16	18	20	*25
Vsebina: keramični adapter, konusni nastavek, distančniki, tesnilni kit, vložek za vratca, gladilka za fuge, navodila za montažo.						
SAP	100117	100118	100119	100120	100121	-
EAN	4037494195659	4037494153819	4037494153826	4037494153833	4037494153840	-
EUR/kos	171,90	173,30	173,30	177,50	183,50	-



Paket priključka za peč 90° Absolut	12	14	16	18	20	25
Vsebina: priključek za peč 33 cm, cev 33 cm, cev 66 cm, distančniki, izolacijski plošči, nosilci izolacije, obroč za ometavanje, žeblički, šablona za izrez, navodila za montažo.						
SAP	100050	100051	100052	100053	100054	100055
EAN	4037494057476	4037494057483	4037494057490	4037494014882	4037494069882	4037494173442
EUR/kos	143,00	147,30	163,20	194,90	216,70	290,00



Paket priključka za vratca Absolut	12	14	16	18	20	25
Vsebina: priključek za vratca 33 cm, cev 33 cm, cev 66 cm, distančniki, dimniška vratca, vložek za vratca, šablona za izrez, navodila za montažo.						
SAP	100164	100165	100166	100167	100168	100169
EAN	4037494195666	4037494183410	4037494183427	4037494183434	4037494183441	4037494183458
EUR/kos	252,70	258,40	272,90	295,90	307,40	380,90

*Pri premeru dimnika Absolut 25 cm, peta dimnika ne obstaja. Montaža po elementih z osnovnim paketom.

Pomembno:

■ Preverite našo tehnično dokumentacijo (slike so simbolične).

ABSOLUT

Enojni Ø 12 - Ø 25 cm

SCHIEDEL
ABSOLUT

Schiedel ABSOLUT

Svetli premer dimnika	12	14	16	18	20	25
-----------------------	----	----	----	----	----	----

Paket priključka za peč 45°
Absolut

Vsebina: priključek za peč 33 cm, cev 33 cm, cev 66 cm, distančniki, izolacijski plošči, nosilci izolacije, šablona za izrez, navodila za montažo.

	12	14	16	18	20	25
SAP	-	100056	100057	100058	100059	100060
EAN	-	4037494074008	4037494074015	4037494074022	4037494074039	4037494174548
EUR/kos	-	153,10	190,60	208,00	213,60	398,10

Malta za zidanje plaščev 10 kg

SAP	100203					
EAN	4037494092859					
EUR/kos	24,80					
Poraba v kg/m	0,7	0,7	0,7	0,7	0,8	1,0

Tesnilni kit Rapid

SAP	100020					
EAN	4037494086124					
EUR/kos	8,90					
Poraba kos/m	0,30	0,30	0,40	0,40	0,50	0,50

Krovna plošča B Absolut

Previs 8,5 cm

	12	14	16	18	20	25
SAP	101915	101915	101915	101915	101919	102492
EAN	4037494070130	4037494070130	4037494070130	4037494070130	4037494070147	4037494802489
EUR/kos	98,30	98,30	98,30	98,30	101,20	311,70

Termo ločilni element

Za termično ločitev dimnika v ostrejšu.

	12	14	16	18	20	25
SAP	149783	149783	149783	149783	149784	-
EAN	4051921711144	4051921711144	4051921711144	4051921711144	4051921711151	-
EUR/kos	147,30	147,30	147,30	147,30	164,70	-

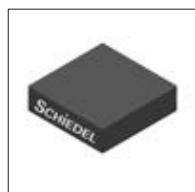
Termo podstavek

Za termično ločitev pete dimnika.

	12	14	16	18	20	25
SAP	173280	173280	173280	173280	173284	173288
EAN	4051921888051	4051921888051	4051921888051	4051921888051	4051921888099	4051921888136
EUR/kos	55,10	55,10	55,10	55,10	69,50	122,40

ABSOLUT

Enojni s termo jaškom

Ø 12 - Ø 20 cm

SCHIEDEL
ABSOLUT

→ Svetli premer dimnika 12L 14L 16L 18L 20L

Dimniški plašč Absolut

3 kosi/m

	12	14	16	18	20
SAP	100024	100024	100024	100024	100028
EAN	4037494136720	4037494136720	4037494136720	4037494136720	4037494141465
EUR/kos	35,00	35,00	35,00	35,00	39,10

Cev Absolut

Dolžina 133 cm

	12-133	14-133	16-133	18-133	20-133
SAP	100037	100038	100039	100040	100041
EAN	4037494057407	4037494014875	4037494057414	4037494057421	4037494066645
EUR/kos	76,80	83,80	93,90	115,60	119,80

Peta dimnika

Višina 107 cm

	12-18L	12-18L	12-18L	12-18L	20L
SAP	143803	143803	143803	143803	143805
EAN	4051921643230	4051921643230	4051921643230	4051921643230	4051921643254
EUR/kos	529,60	529,60	529,60	529,60	654,90

+

Paket pete dimnika Absolut

Vsebina: keramični adapter, konusni nastavek, distančniki, tesnilni kit, vložek za vratca, gladilka za fuge, navodila za montažo.

	12	14	16	18	20
SAP	100117	100118	100119	100120	100121
EAN	4037494195659	4037494153819	4037494153826	4037494153833	4037494153840
EUR/kos	171,90	173,30	173,30	177,50	183,50

Paket priključka za peč 90° Absolut

Vsebina: priključek za peč 33 cm, cev 33 cm, cev 66 cm, distančniki, izolacijski plošči, nosilci izolacije, obroč za ometavanje, žeblički, šablona za izrez, navodila za montažo.

	12	14	16	18	20
SAP	100050	100051	100052	100053	100054
EAN	4037494057476	4037494057483	4037494057490	4037494014882	4037494069882
EUR/kos	143,00	147,30	163,20	194,90	216,70

Paket priključka za vratca Absolut

Vsebina: priključek za vratca 33 cm, cev 33 cm, cev 66 cm, distančniki, dimniška vratca, vložek za vratca, šablona za izrez, navodila za montažo.

	12	14	16	18	20
SAP	100164	100165	100166	100167	100168
EAN	4037494195666	4037494183410	4037494183427	4037494183434	4037494183441
EUR/kos	252,70	258,40	272,90	295,90	307,40

Pomembno:

■ Preverite našo tehnično dokumentacijo (slike so simbolične).

ABSOLUT

Enojni s termo jaškom

Ø 12 - Ø 20 cm

SCHIEDEL
ABSOLUT

Schiedel ABSOLUT

Svetli premer dimnika	12L	14L	16L	18L	20L
-----------------------	-----	-----	-----	-----	-----

Paket priključka za peč 45°
Absolut

Vsebina: priključek za peč 33 cm, cev 33 cm, cev 66 cm, distančniki, izolacijski plošči, nosilci izolacije, šablona za izrez, navodila za montažo.

	12	14	16	18	20
SAP	-	100056	100057	100058	100059
EAN	-	4037494074008	4037494074015	4037494074022	4037494074039
EUR/kos	-	153,10	190,60	208,00	213,60

Malta za zidanje plaščev 10 kg

SAP	100203				
EAN	4037494092859				
EUR/kos	24,80				
Poraba v kg/m	0,8	0,8	0,8	0,8	0,9

Tesnilni kit Rapid

SAP	100020				
EAN	4037494086124				
EUR/kos	8,90				
Poraba kos/m	0,30	0,30	0,40	0,40	0,50

Krovna plošča B Absolut

Previs 8,5 cm

	12	14	16	18	20
SAP	101916	101916	101916	101916	101920
EAN	4037494070154	4037494070154	4037494070154	4037494070154	4037494070161
EUR/kos	109,70	109,70	109,70	109,70	114,40

Termo ločilni element

Za termično ločitev dimnika v ostrejšu.

	12-18L	12-18L	12-18L	12-18L	20L
SAP	149786	149786	149786	149786	149787
EAN	4051921711175	4051921711175	4051921711175	4051921711175	4051921711182
EUR/kos	173,30	173,30	173,30	173,30	189,30

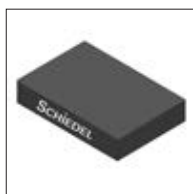
Termo podstavek

Za termično ločitev pete dimnika.

	12-18L	12-18L	12-18L	12-18L	20L
SAP	173281	173281	173281	173281	173285
EAN	4051921888068	4051921888068	4051921888068	4051921888068	4051921888105
EUR/kos	62,10	62,10	62,10	62,10	76,80

Tehnične spremembe pridržane. Veljavnost cenika od 20. 3. 2024 do preklica.

ABSOLUT

Dvojni Ø 14 - Ø 18 cm

SCHIEDEL
ABSOLUT

→ Svetli premer dimnika 14/14 16/16 18/18

Dimniški plašč Absolut

3 kosi/m

	14-18/14-18	14-18/14-18	14-18/14-18
SAP	100025	100025	100025
EAN	4037494055076	4037494055076	4037494055076
EUR/kos	47,70	47,70	47,70

Cev Absolut

Dolžina 133 cm

	14-133	16-133	18-133
SAP	100038	100039	100040
EAN	4037494014875	4037494057414	4037494057421
EUR/kos	83,80	93,90	115,60

Peta dimnika

Višina 107 cm

	14-18/14-18	14-18/14-18	14-18/14-18
SAP	143806	143806	143806
EAN	4051921643261	4051921643261	4051921643261
EUR/kos	933,10	933,10	933,10

+

Paket pete dimnika Absolut

Vsebina: keramični adapter, konusni nastavek, distančniki, tesnilni kit, vložek za vratca, gladilka za fuge, navodila za montažo.

	14	16	18
SAP	100118	100119	100120
EAN	4037494153819	4037494153826	4037494153833
EUR/kos	173,30	173,30	177,50

Paket priključka za peč 90° Absolut

Vsebina: priključek za peč 33 cm, cev 33 cm, cev 66 cm, distančniki, izolacijski plošči, nosilci izolacije, obroč za ometavanje, žeblički, šablona za izrez, navodila za montažo.

	14	16	18
SAP	100051	100052	100053
EAN	4037494057483	4037494057490	4037494014882
EUR/kos	147,30	163,20	194,90

Paket priključka za vratca Absolut

Vsebina: priključek za vratca 33 cm, cev 33 cm, cev 66 cm, distančniki, dimniška vratca, vložek za vratca, šablona za izrez, navodila za montažo.

	14	16	18
SAP	100165	100166	100167
EAN	4037494183410	4037494183427	4037494183434
EUR/kos	258,40	272,90	295,90

Pomembno:

■ Preverite našo tehnično dokumentacijo (slike so simbolične).

ABSOLUT

Dvojni Ø 14 - Ø 18 cm

SCHIEDEL
ABSOLUT

Svetli premer dimnika	14/14	16/16	18/18
-----------------------	-------	-------	-------

Paket priključka za peč 45°
Absolut

Vsebina: priključek za peč 33 cm, cev 33 cm, cev 66 cm, distančniki, izolacijski plošči, nosilci izolacije, šablona za izrez, navodila za montažo.

	14	16	18
SAP	100056	100057	100058
EAN	4037494074008	4037494074015	4037494074022
EUR/kos	153,10	190,60	208,00

Malta za zidanje plaščev 10 kg

SAP	100203		
EAN	4037494092859		
EUR/kos	24,80		
Poraba v kg/m	0,8	0,8	0,8



Tesnilni kit Rapid

SAP	100020		
EAN	4037494086124		
EUR/kos	8,90		
Poraba kos/m	0,30	0,40	0,40

Krovna plošča B Absolut

Previs 8,5 cm

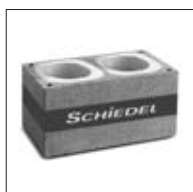
	14/14	16/16	18/18
SAP	101917	101917	101917
EAN	4037494070178	4037494070178	4037494070178
EUR/kos	122,90	122,90	122,90

Termo ločilni element

Za termično ločitev dimnika v ostrejšu.

	14-18/14-18	14-18/14-18	14-18/14-18
SAP	149789	149789	149789
EAN	4051921711205	4051921711205	4051921711205
EUR/kos	210,80	210,80	210,80

Termo podstavek

Za termično ločitev pete dimnika.

	14-18/14-18	14-18/14-18	14-18/14-18
SAP	173282	173282	173282
EAN	4051921888075	4051921888075	4051921888075
EUR/kos	100,10	100,10	100,10

ABSOLUT

Dvojni s termo jaškom

Ø 14 - Ø 18 cm

SCHIEDEL
ABSOLUT

→ Svetli premer dimnika 14/L/14 16/L/16 18/L/18



Dimniški plašč Absolut	14-18/L/14-18	14-18/L/14-18	14-18/L/14-18
3 kosi/m			
SAP	100026	100026	100026
EAN	4037494137031	4037494137031	4037494137031
EUR/kos	60,90	60,90	60,90



Cev Absolut	14-133	16-133	18-133
Dolžina 133 cm			
SAP	100038	100039	100040
EAN	4037494014875	4037494057414	4037494057421
EUR/kos	83,80	93,90	115,60



Peta dimnika	14-18/L/14-18	14-18/L/14-18	14-18/L/14-18
Višina 107 cm			
SAP	143808	143808	143808
EAN	4051921643285	4051921643285	4051921643285
EUR/kos	972,10	972,10	972,10

+



Paket pete dimnika Absolut	14	16	18
Vsebina: keramični adapter, konusni nastavek, distančniki, tesnilni kit, vložek za vratca, gladilka za fuge, navodila za montažo.			
SAP	100118	100119	100120
EAN	4037494153819	4037494153826	4037494153833
EUR/kos	173,30	173,30	177,50



Paket priključka za peč 90° Absolut	14	16	18
Vsebina: priključek za peč 33 cm, cev 33 cm, cev 66 cm, distančniki, izolacijski plošči, nosilci izolacije, obroč za ometavanje, žeblički, šablona za izrez, navodila za montažo.			
SAP	100051	100052	100053
EAN	4037494057483	4037494057490	4037494014882
EUR/kos	147,30	163,20	194,90



Paket priključka za vratca Absolut	14	16	18
Vsebina: priključek za vratca 33 cm, cev 33 cm, cev 66 cm, distančniki, dimniška vratca, vložek za vratca, šablona za izrez, navodila za montažo.			
SAP	100165	100166	100167
EAN	4037494183410	4037494183427	4037494183434
EUR/kos	258,40	272,90	295,90

Pomembno:

- Preverite našo tehnično dokumentacijo (slike so simbolične).

ABSOLUT

Dvojni s termo jaškom

Ø 14 - Ø 18 cm

SCHIEDEL
ABSOLUT

Schiedel ABSOLUT

→ Svetli premer dimnika	14/L/14	16/L/16	18/L/18
-------------------------	---------	---------	---------

Paket priključka za peč 45°
Absolut

Vsebina: priključek za peč 33 cm, cev 33 cm, cev 66 cm, distančniki, izolacijski plošči, nosilci izolacije, šablona za izrez, navodila za montažo.

	14	16	18
SAP	100056	100057	100058
EAN	4037494074008	4037494074015	4037494074022
EUR/kos	153,10	190,60	208,00

Malta za zidanje plašcev 10 kg

SAP	100203		
EAN	4037494092859		
EUR/kos	24,80		
Poraba v kg/m	0,9	0,9	0,9

Tesnilni kit Rapid

SAP	100020		
EAN	4037494086124		
EUR/kos	8,90		
Poraba kos/m	0,30	0,40	0,40

Krovna plošča B Absolut

Previs 8,5 cm

	14/L/14	16/L/16	18/L/18
SAP	101918	101918	101918
EAN	4037494070192	4037494070192	4037494070192
EUR/kos	131,50	131,50	131,50

Termo ločilni element

Za termično ločitev dimnika v ostrejšu.

	14-18/L/14-18	14-18/L/14-18	14-18/L/14-18
SAP	149791	149791	149791
EAN	4051921711229	4051921711229	4051921711229
EUR/kos	235,30	235,30	235,30

Termo podstavek

Za termično ločitev pete dimnika.

	14-18/L/14-18	14-18/L/14-18	14-18/L/14-18
SAP	173283	173283	173283
EAN	4051921888082	4051921888082	4051921888082
EUR/kos	105,50	105,50	105,50

ABSOLUT

Kombinirani Ø 14 - Ø 20 cm

SCHIEDEL
ABSOLUT

Svetli premer dimnika	16/14	18/14	18/16	20/14	20/16	20/18
-----------------------	-------	-------	-------	-------	-------	-------

Dimniški plašč Absolut

3 kosi/m

	16/14	18/14	18/16	20/14	20/16	20/18
SAP	100025	100025	100025	100029	100029	100029
EAN	4037494055076	4037494055076	4037494055076	4037494068984	4037494068984	4037494068984
EUR/kos	47,70	47,70	47,70	55,10	55,10	55,10

Cev Absolut

Dolžina 133 cm

	16-133	18-133	18-133	20-133	20-133	20-133
SAP	100039	100040	100040	100041	100041	100041
EAN	4037494057414	4037494057421	4037494057421	4037494066645	4037494066645	4037494066645
EUR/kos	93,90	115,60	115,60	119,80	119,80	119,80
	14-133	14-133	16-133	14-133	16-133	18-133
SAP	100038	100038	100039	100038	100039	100040
EAN	4037494014875	4037494014875	4037494057414	4037494014875	4037494057414	4037494057421
EUR/kos	83,80	83,80	93,90	83,80	93,90	115,60

Peta dimnika

Višina 107 cm

	14-18	14-18	14-18	14-18/20	14-18/20	14-18/20
SAP	143806	143806	143806	143807	143807	143807
EAN	4051921643261	4051921643261	4051921643261	4051921643278	4051921643278	4051921643278
EUR/kos	933,10	933,10	933,10	1018,10	1018,10	1018,10

+

Paket pete dimnika Absolut

Vsebina: keramični adapter, konusni nastavek, distančniki, tesnilni kit, vložek za vratca, gladilka za fuge, navodila za montažo.

	16	18	18	20	20	20
SAP	100119	100120	100120	100121	100121	100121
EAN	4037494153826	4037494153833	4037494153833	4037494153840	4037494153840	4037494153840
EUR/kos	173,30	177,50	177,50	183,50	183,50	183,50
	14	14	16	14	16	18
SAP	100118	100118	100119	100118	100119	100120
EAN	4037494153819	4037494153819	4037494153826	4037494153819	4037494153826	4037494153833
EUR/kos	173,30	173,30	173,30	173,30	173,30	177,50

Paket priključka za peč 90° Absolut

Vsebina: priključek za peč 33 cm, cev 33 cm, cev 66 cm, distančniki, izolacijski plošči, nosilci izolacije, obroč za ometavanje, žeblički, šablona za izrez, navodila za montažo.

	16	18	18	20	20	20
SAP	100052	100053	100053	100054	100054	100054
EAN	4037494057490	4037494014882	4037494014882	4037494069882	4037494069882	4037494069882
EUR/kos	163,20	194,90	194,90	216,70	216,70	216,70
	14	14	16	14	16	18
SAP	100051	100051	100052	100051	100052	100053
EAN	4037494057483	4037494057483	4037494057490	4037494057483	4037494057490	4037494014882
EUR/kos	147,30	147,30	163,20	147,30	163,20	194,90

Paket priključka za vratca Absolut

Vsebina: priključek za vratca 33 cm, cev 33 cm, cev 66 cm, distančniki, dimniška vratca, vložek za vratca, šablona za izrez, navodila za montažo.

	16	18	18	20	20	20
SAP	100166	100167	100167	100168	100168	100168
EAN	4037494183427	4037494183434	4037494183434	4037494183441	4037494183441	4037494183441
EUR/kos	272,90	295,90	295,90	307,40	307,40	307,40
	14	14	16	14	16	18
SAP	100165	100165	100166	100165	100166	100167
EAN	4037494183410	4037494183410	4037494183427	4037494183410	4037494183427	4037494183434
EUR/kos	258,40	258,40	272,90	258,40	272,90	295,90

Pomembno:

■ Preverite našo tehnično dokumentacijo (slike so simbolične).

ABSOLUT

Kombinirani Ø 14 - Ø 20 cm

SCHIEDEL
ABSOLUT

Schiedel ABSOLUT

→ Svetli premer dimnika	16/14	18/14	18/16	20/14	20/16	20/18
-------------------------	-------	-------	-------	-------	-------	-------

Paket priključka za peč 45°
Absolut

Vsebina: priključek za peč 33 cm, cev 33 cm, cev 66 cm, distančniki, izolacijski plošči, nosilci izolacije, šablona za izrez, navodila za montažo.

	16	18	18	20	20	20
SAP	100057	100058	100058	100059	100059	100059
EAN	4037494074015	4037494074022	4037494074022	4037494074039	4037494074039	4037494074039
EUR/kos	190,60	208,00	208,00	213,60	213,60	213,60
	14	14	16	14	16	18
SAP	100056	100056	100057	100056	100057	100058
EAN	4037494074008	4037494074008	4037494074015	4037494074008	4037494074015	4037494074022
EUR/kos	153,10	153,10	190,60	153,10	190,60	208,00

Malta za zidanje plašev 10 kg

SAP	100203					
EAN	4037494092859					
EUR/kos	24,80					
Poraba v kg/m	0,8	0,8	0,8	0,9	0,9	0,9



Tesnilni kit Rapid

SAP	100020					
EAN	4037494086124					
EUR/kos	8,90					
Poraba kos/m	0,30	0,40	0,40	0,50	0,50	0,50

Krovna plošča B Absolut

Previs 8,5 cm

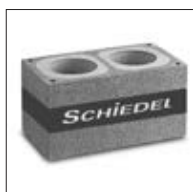
	16/14	18/14	18/16	20/14	20/16	20/18
SAP	101917	101917	101917	101921	101921	101921
EAN	4037494070178	4037494070178	4037494070178	4037494070185	4037494070185	4037494070185
EUR/kos	122,90	122,90	122,90	127,20	127,20	127,20

Termo ločilni element

Za termično ločitev dimnika v ostrejšju.

	14-18	14-18	14-18	14-18/20	14-18/20	14-18/20
SAP	149789	149789	149789	149790	149790	149790
EAN	4051921711205	4051921711205	4051921711205	4051921711212	4051921711212	4051921711212
EUR/kos	210,80	210,80	210,80	226,80	226,80	226,80

Termo podstavek

Za termično ločitev pete dimnika.

	14-18	14-18	14-18	14-18/20	14-18/20	14-18/20
SAP	173282	173282	173282	173286	173286	173286
EAN	4051921888075	4051921888075	4051921888075	4051921888112	4051921888112	4051921888112
EUR/kos	100,10	100,10	100,10	112,80	112,80	112,80

Tehnične spremembe pridržane. Veljavnost cenika od 20. 3. 2024 do preklica.

ABSOLUT

Kombinirani s termo jaškom

Ø 14 - Ø 20 cm

SCHIEDEL
ABSOLUT

Svetli premer dimnika	16/L/14	18/L/14	18/L/16	20/L/14	20/L/16	20/L/18
-----------------------	---------	---------	---------	---------	---------	---------



Dimniški plašč Absolut	16/TL/14	18/TL/14	18/TL/16	20/TL/14	20/TL/16	20/TL/18
3 kosi/m						
SAP	100026	100026	100026	100030	100030	100030
EAN	4037494137031	4037494137031	4037494137031	4037494141472	4037494141472	4037494141472
EUR/kos	60,90	60,90	60,90	69,50	69,50	69,50



Cev Absolut	16-133	18-133	18-133	20-133	20-133	20-133
Dolžina 133 cm						
SAP	100039	100040	100040	100041	100041	100041
EAN	4037494057414	4037494057421	4037494057421	4037494066645	4037494066645	4037494066645
EUR/kos	93,90	115,60	115,60	119,80	119,80	119,80
	14-133	14-133	16-133	14-133	16-133	18-133
SAP	100038	100038	100039	100038	100039	100040
EAN	4037494014875	4037494014875	4037494057414	4037494014875	4037494057414	4037494057421
EUR/kos	83,80	83,80	93,90	83,80	93,90	115,60



Peta dimnika	16/L/14	18/L/14	18/L/16	20/L/14	20/L/16	20/L/18
Višina 107 cm						
SAP	143808	143808	143808	143809	143809	143809
EAN	4051921643285	4051921643285	4051921643285	4051921643292	4051921643292	4051921643292
EUR/kos	972,10	972,10	972,10	1061,60	1061,60	1061,60

+



Paket pete dimnika Absolut	16	18	18	20	20	20
Vsebina: keramični adapter, konusni nastavek, distančniki, tesnilni kit, vložek za vratca, gladilka za fuge, navodila za montažo.						
SAP	100119	100120	100120	100121	100121	100121
EAN	4037494153826	4037494153833	4037494153833	4037494153840	4037494153840	4037494153840
EUR/kos	173,30	177,50	177,50	183,50	183,50	183,50
	14	14	16	14	16	18
SAP	100118	100118	100119	100118	100119	100120
EAN	4037494153819	4037494153819	4037494153826	4037494153819	4037494153826	4037494153833
EUR/kos	173,30	173,30	173,30	173,30	173,30	177,50



Paket priključka za peč 90° Absolut	16	18	18	20	20	20
Vsebina: priključek za peč 33 cm, cev 33 cm, cev 66 cm, distančniki, izolacijski plošči, nosilci izolacije, obroč za ometavanje, žbljički, šablona za izrez, navodila za montažo.						
SAP	100052	100053	100053	100054	100054	100054
EAN	4037494057490	4037494014882	4037494014882	4037494069882	4037494069882	4037494069882
EUR/kos	163,20	194,90	194,90	216,70	216,70	216,70
	14	14	16	14	16	18
SAP	100051	100051	100052	100051	100052	100053
EAN	4037494057483	4037494057483	4037494057490	4037494057483	4037494057490	4037494014882
EUR/kos	147,30	147,30	163,20	147,30	163,20	194,90



Paket priključka za vratca Absolut	16	18	18	20	20	20
Vsebina: priključek za vratca 33 cm, cev 33 cm, cev 66 cm, distančniki, dimniška vratca, vložek za vratca, šablona za izrez, navodila za montažo.						
SAP	100166	100167	100167	100168	100168	100168
EAN	4037494183427	4037494183434	4037494183434	4037494183441	4037494183441	4037494183441
EUR/kos	272,90	295,90	295,90	307,40	307,40	307,40
	14	14	16	14	16	18
SAP	100165	100165	100166	100165	100166	100167
EAN	4037494183410	4037494183410	4037494183427	4037494183410	4037494183427	4037494183434
EUR/kos	258,40	258,40	272,90	258,40	272,90	295,90

Pomembno:

■ Preverite našo tehnično dokumentacijo (slike so simbolične).

ABSOLUT

Kombinirani s termo jaškom

Ø 14 - Ø 20 cm

SCHIEDEL
ABSOLUT

Schiedel ABSOLUT

Svetli premer dimnika	16/L/14	18/L/14	18/L/16	20/L/14	20/L/16	20/L/18
-----------------------	---------	---------	---------	---------	---------	---------

Paket priključka za peč 45°
Absolut

Vsebina: priključek za peč 33 cm, cev 33 cm, cev 66 cm, distančniki, izolacijski plošči, nosilci izolacije, šablona za izrez, navodila za montažo.

	16	18	18	20	20	20
SAP	100057	100058	100058	100059	100059	100059
EAN	4037494074015	4037494074022	4037494074022	4037494074039	4037494074039	4037494074039
EUR/kos	190,60	208,00	208,00	213,60	213,60	213,60
	14	14	16	14	16	18
SAP	100056	100056	100057	100056	100057	100058
EAN	4037494074008	4037494074008	4037494074015	4037494074008	4037494074015	4037494074022
EUR/kos	153,10	153,10	190,60	153,10	190,60	208,00

Malta za zidanje plašcev 10 kg

SAP	100203					
EAN	4037494092859					
EUR/kos	24,80					
Poraba v kg/m	0,8	0,8	0,8	0,9	0,9	0,9

Tesnilni kit Rapid

SAP	100020					
EAN	4037494086124					
EUR/kos	8,90					
Poraba kos/m	0,30	0,40	0,40	0,50	0,50	0,50

Krovna plošča B Absolut

Previs 8,5 cm

	16/TL/14	18/TL/14	18/TL/16	20/TL/14	20/TL/16	20/TL/18
SAP	101918	101918	101918	101922	101922	101922
EAN	4037494070192	4037494070192	4037494070192	4037494070208	4037494070208	4037494070208
EUR/kos	131,50	131,50	131,50	134,40	134,40	134,40

Termo ločilni element

Za termično ločitev dimnika v ostrejšu.

	14-18/L/14-18	14-18/L/14-18	14-18/L/14-18	14-18/L/20	14-18/L/20	14-18/L/20
SAP	149791	149791	149791	149792	149792	149792
EAN	4051921711229	4051921711229	4051921711229	4051921711236	4051921711236	4051921711236
EUR/kos	235,30	235,30	235,30	262,80	262,80	262,80

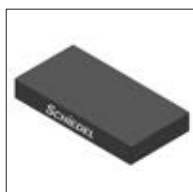
Termo podstavek

Za termično ločitev pete dimnika.

	14-18/L/14-18	14-18/L/14-18	14-18/L/14-18	14-18/L/20	14-18/L/20	14-18/L/20
SAP	173283	173283	173283	173287	173287	173287
EAN	4051921888082	4051921888082	4051921888082	4051921888129	4051921888129	4051921888129
EUR/kos	105,50	105,50	105,50	117,10	117,10	117,10

Tehnične spremembe pridržane. Veljavnost cenika od 20. 3. 2024 do preklica.

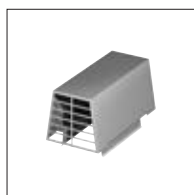

Kapa ventilacijskega jaška	EZ 14-20	ZZ 14-20
SAP	100224	100225
EAN	4037494143414	4037494143421
EUR/kos	52,20	53,60



Pokrov ventilacijskega jaška	12/28	13/26	14/28
SAP	100228	100229	100230
EAN	4037494143445	4037494143452	4037494143469
EUR/kos	32,20	32,20	36,70



Paket dodatnega priključka za peč 90° Absolut	14	16	18	20	25
SAP	100068	100069	100070	100071	100072
EAN	4037494136102	4037494136119	4037494136126	4037494136225	4037494174579
EUR/kos	83,80	95,40	101,20	126,00	146,00

Vsebina: nos priključka za peč, ognjeobstojno lepilo, izolacijski plošči, nosilci izolacije, obroč za ometavanje, žeblički, šablona za izrez, žaga, navodila za montažo.



Paket dodatnega priključka za peč 45° Absolut	14	16	18	20	25
SAP	100073	100074	100075	100076	100077
EAN	4037494136188	4037494136195	4037494136201	4037494136218	4037494174586
EUR/kos	83,80	95,40	101,20	101,20	107,00

Vsebina: nos priključka za peč, ognjeobstojno lepilo, izolacijski plošči, nosilci izolacije, šablona za izrez, žaga, navodila za montažo.



Paket dodatnega priključka za vratca Absolut	14	16	18	20	25
SAP	100185	100186	100187	100188	100189
EAN	4037494183465	4037494183472	4037494183489	4037494183496	4037494183502
EUR/kos	226,80	229,60	232,20	235,30	297,30

Vsebina: nos priključka za vratca, ognjeobstojno lepilo, dimniška vratca, vložek za vratca, šablona za izrez, žaga, navodila za montažo.



Adapter za plinsko peč	KAPP 160/200	APP 160/55	-	APP 200/70
SAP	100018	100016	-	100015
EAN	4037494074343	4037494012833	-	4037494281017
EUR/kos	183,50	92,60	-	119,80

*Absolut 14 cm lahko izvedemo kot koaksialni dimnik, zato sta v setu dva adapterja.

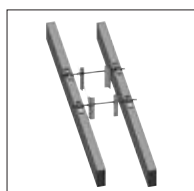

Držalo dimnika Standard	
SAP	100514
EAN	4037494175088
EUR/kos	221,00



Ojačitveni set in zalivna malta	SET 4 x 4m M12	SET 4 x 6m M12
SAP	133661	133663
EAN	4037494034491	4037494034484
EUR/kos	104,00	146,40

Pomembno:

- Preverite našo tehnično dokumentacijo (slike so simbolične).



ABS Pokrov proti padavinam 1218	14	16	18	20	25
SAP	100234	100234	100234	100235	100236
EAN	4049723004236	4049723004236	4049723004236	4049723004243	4049723004250
EUR/kos	52,20	52,20	52,20	72,50	72,50



Regulator vleka z eksplozijsko loputo	16	+	16	18	20	25
SAP	101697		101724	108188	108189	108190
EAN	4037494266458		4037494267011	4037494807231	4037494807248	4037494807255
EUR/kos	133,10		47,40	281,40	281,40	301,70



Adapter za dovod zraka ABS					
Za dovod zraka iz ventilacijskega jaška. Za kurišča, neodvisna od zraka v prostoru.	SAP	100206			
	EAN	4037494832592			
	EUR/kos	174,10			



Vrečka za kondenz s sklopko					
	SAP	900014779			
	EAN	4051921809360			
	EUR/kos	77,40			



ABS Diamantna rezalka	115 mm	230 mm	
	SAP	101871	101872
	EAN	4037494088746	4037494088753
	EUR/kos	49,30	121,40



Ventilacijska vratca - bela					
	SAP	100341			
	EAN	4037494135396			
	EUR/kos	37,70			



Dekorativna vratca Absolut 25 x 65 cm					
	SAP	149507			
	EAN	40519217009172			
	EUR/kos	210,30			



Vratca za kondenzat - kromirana 15 x 15 cm					
	SAP	137660			
	EAN	4051921606426			
	EUR/kos	24,00			

ABSOLUT

Vsebine posameznih paketov

SCHIEDEL
ABSOLUT

Paket pete dimnika

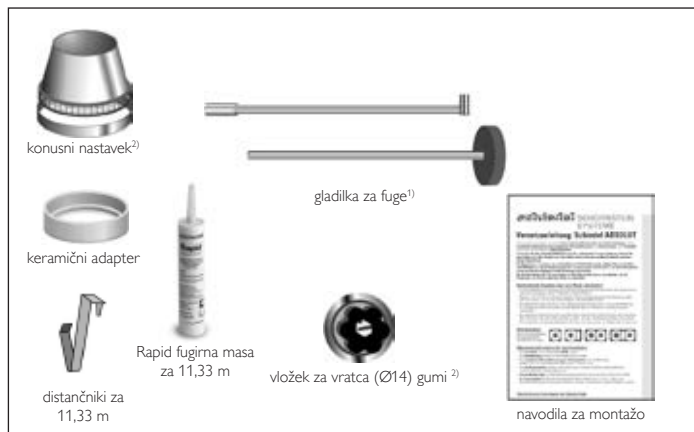

¹⁾ navojne palice so v peti dimnika,

²⁾ pri Ø 16, 18 in 20 drugačna izvedba

Paket priključka za peč 90°

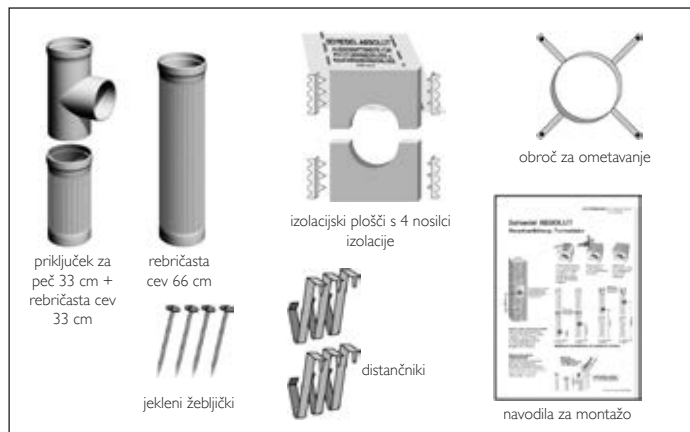

Paket priključka za vratca (za zgorna čistilna vratca)



Paket dodatnega priključka za peč 90° (za naknadno vgradnjo)

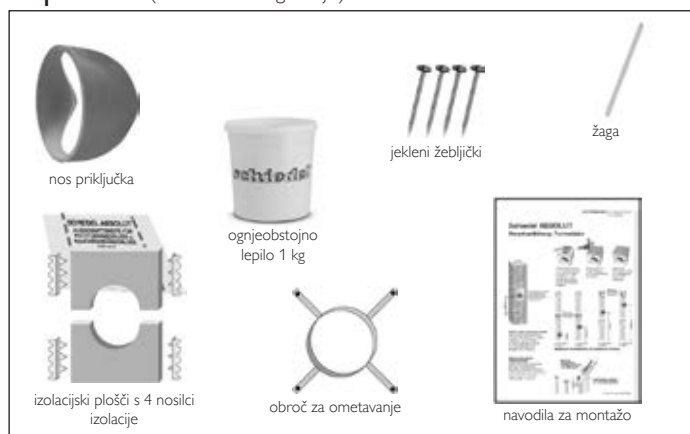

Paket dodatnega priključka za vratca (za naknadno vgradnjo)



¹⁾ pri Ø 16, 18 in 20 drugačna izvedba

Paket dodatnega priključka za peč 45° (za naknadno vgradnjo)

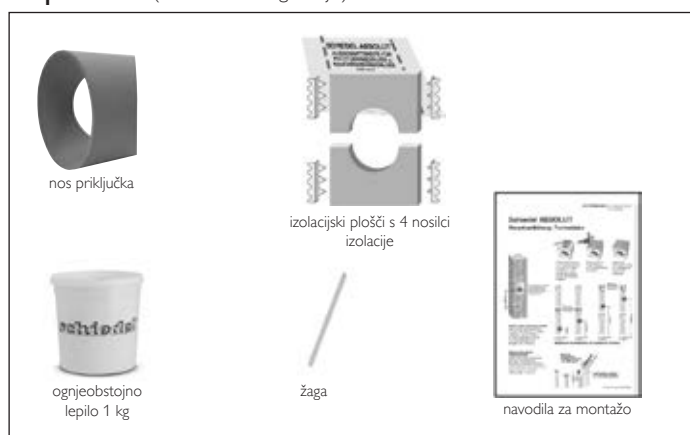

Pomembno:

■ Preverite našo tehnično dokumentacijo (slike so simbolične).

Obložni elementi za ABSOLUT

Glede statične stabilnosti dimnika upoštevajte navodila za montažo oz. se posvetujte s tehnično službo Schiedel!

Obložni element je sestavljen iz strukturnih stranic v željeni barvi, krovne plošče in distančnih vijakov.

SAP 990000040
EAN 4051921541222



Struktura: opeka
Barva: opečno rdeča, klinker rdeča, manga, bela, črna



Struktura: omet rdeča
Barva: opečno rdeča, klinker rdeča, manga, bela, črna



Struktura: gladka
Barva: opečno rdeča, klinker rdeča, manga, bela, črna

Tip dimnika	Svetli Ø cm	Oznaka elementa	Zun. mere plašča v cm	Zun. mere obložnega elementa v cm	Masa v kg/m	Višina cm							
						75	100	125	150	175	200	225	250
 Enojni	14	OE EZ 14-18	36/36	49/49	54	405,20	487,60	570,00	652,40	734,80	817,20	899,60	982,00
	16	OE EZ 14-18	36/36	49/49	54								
	18	OE EZ 14-18	36/36	49/49	54								
	20	OE EZ 20	38/38	49/49	54	427,60	513,80	600,00	686,20	772,40	858,60	944,80	1031,00
	25	OE EZ 25	48/48	67/67	79	586,90	678,40	769,90	861,40	952,90	1044,40	1135,90	1227,40
 Enojni z ventilacijo	14TL	OE EZL 1418	36/50	49/67	66	439,20	524,20	609,20	694,20	779,20	864,20	949,20	1034,20
	16TL	OE EZL 1418	36/50	49/67	66								
	18TL	OE EZL 1418	36/50	49/67	66								
	20TL	OE EZL 20	38/54	49/67	66	462,80	549,00	635,20	721,40	807,60	893,80	980,00	1066,20
 Dvojni	1414	OE ZZ 1418	36/65	49/80	74	541,10	632,60	724,10	815,60	907,10	998,60	1090,10	1181,60
	1616	OE ZZ 1418	36/65	49/80	74								
	1818	OE ZZ 1418	36/65	49/80	74								
 Dvojni kombinirani	1614	OE ZZK 1420	36/65	49/80	74	555,50	656,10	756,70	857,30	957,90	1058,50	1159,10	1259,70
	1814	OE ZZK 1420	36/65	49/80	74								
	1816	OE ZZK 1420	36/65	49/80	74								
	2014	OE ZZK 1420	38/71	49/80	74								
	2016	OE ZZK 1420	38/71	49/80	74								
2018	OE ZZK 1420	38/71	49/80	74									
 Dvojni z ventilacijo	14TL14	OE ZZL 1418	36/83	49/99	85	546,30	637,80	729,30	820,80	912,30	1003,80	1095,30	1186,80
	16TL16	OE ZZL 1418	36/83	49/99	85								
	18TL18	OE ZZL 1418	36/83	49/99	85								
 Dvojni kombinirani z ventilacijo	16TL14	OE ZZLK 1420	36/83	49/99	85	611,60	720,30	829,00	937,70	1046,40	1155,10	1263,80	1372,50
	18TL14	OE ZZLK 1420	36/83	49/99	85								
	18TL16	OE ZZLK 1420	36/83	49/99	85								
	20TL14	OE ZZLK 1420	38/88	49/99	85								
	20TL16	OE ZZLK 1420	38/88	49/99	85								
	20TL18	OE ZZLK 1420	38/88	49/99	85								

Naročnik:	SCHIEDEL d.o.o. Latkova vas 82 3312 Prebold Slovenija
Za stranko / gradbišče:	T 03 703 82 00 F 03 703 82 65 info.si@schiedel.com www.schiedel.si
Telefon:	<input type="checkbox"/> Lasten prevoz <input type="checkbox"/> Dostava iz skladišča
Datum naročila:	Montaža: <input type="checkbox"/> Da <input type="checkbox"/> Ne

SCHIEDEL

Naročilo obložnega elementa št.:

Na podlagi posredovanih podatkov za dimnik _____ premera _____ naročamo _____ kos(ov) obložnih elementov.

Št. naloga:

Šifra izdelka:

Struktura:

- opečna
 omet
 gladka

Zaključek:

- konus
 omega
 z rozeto

Določanje višine elementa:
višina dimnika nad streho (h), zaokrožena na naslednjo večjo standardno višino

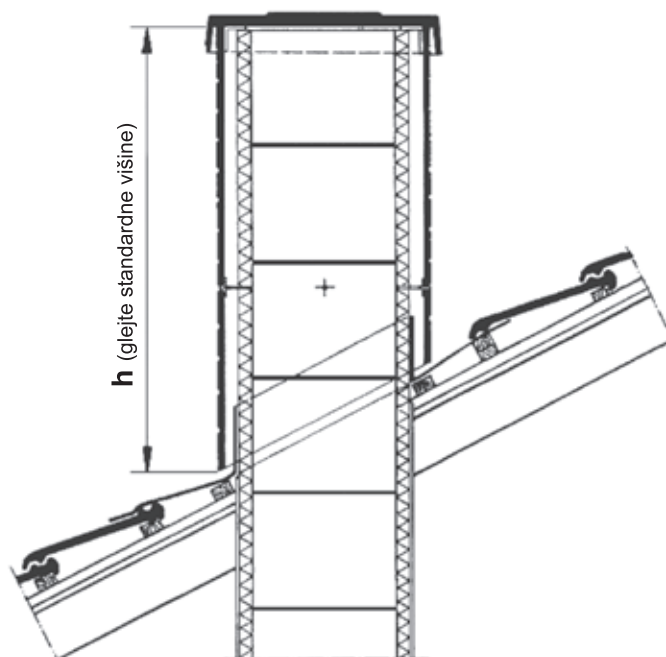

Barva:

- opečno rdeča
 klinker rdeča
 rjava
 bela
 antracit črna

Višina (cm):

- 75 175
 100 200
 125 225
 150 250

Naklon strehe: _____°

Opomba:

V primeru enojnega dimnika z zračnikom ali dvojnega kombiniranega dimnika označite položaj slemena z **X**!

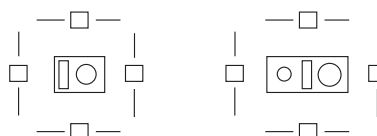

Naročnik s podpisom zagotavlja, da so podatki pravilni in s tem prevzema vse stroške, ki bi nastali zaradi netočnih podatkov.

Dobavni rok:

Podpis naročnika:

Podpis prodajnega referenta:

Pomembno:

Preverite našo tehnično dokumentacijo (slike so simbolične).

→ Schiedel UNI ISO Plus



Univerzalni dimniški sistem z novo isostatično keramično cevjo.

SCHIEDEL

UNI ISO PLUS

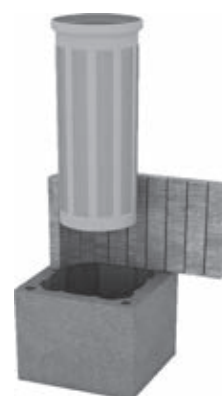

UNI ISO Plus

Enojni Ø 14 - Ø 20 cm

SCHIEDEL
UNI ISO PLUS

→ Svetli premer dimnika	14	16	18	20
-------------------------	----	----	----	----



Dimnik UNI ISO plus EZ	Tip	UNI plus 14	UNI plus 16	UNI plus 18	UNI plus 20
Zunanja mera		32/32	32/32	36/36	36/36
Teža kg/m		63	63	74	76



Dimniški plašč		14	16	18	20
Višina 33 cm, 3 kos/m	SAP	100351	100351	100353	100353
	EAN	4037494089569	4037494089569	4037494089934	4037494089934
	EUR/kos	13,20	13,20	14,80	14,80



Podstavek kondenzne posode UNI ISO plus		14	16	18	20
Višina 16,6 cm	SAP	132557	132557	132557	132557
	EAN	3831054740867	3831054740867	3831054740867	3831054740867
	EUR/kos	17,60	17,60	17,60	17,60

+



Osnovni paket UNI ISO plus		14	16	18	20
Vsebina: kondenzna posoda z odvodom, notranje zapiralo vratc G, dimniška vratca, ventilacijska rešetka, šablona za maltanje, izolacijske plošče za RA priključek, zaščitni karton in obroč za ometavanje, ognjeobstojno lepilo rapid v kartuši (3 kos), pištola za kartuše, navodilo za montažo.	SAP	135700	135701	135702	135703
	EAN	4051921574800	4051921574817	4051921574824	4051921574831
	EUR/kos	186,40	191,90	206,40	215,20



Priključek za dimniška vratca		14	16	18	20
Višina 33 cm	SAP	102122	102123	102124	102125
	EAN	4037494137390	4037494142233	4037494119044	4037494168097
	EUR/kos	49,30	52,20	66,50	68,10



Priključek za peč pod kotom 90°		14	16	18	20
Višina 33 cm	SAP	102025	102109	102110	102111
	EAN	4037494066027	4037494142226	4037494119051	4037494168080
	EUR/kos	45,00	47,70	60,90	62,10

Pomembno:

- Preverite našo tehnično dokumentacijo (slike so simbolične).

UNI ISO Plus

Enojni Ø 14 - Ø 20 cm

SCHIEDEL

UNI ISO PLUS

→ Svetli premer dimnika	14	16	18	20
-------------------------	----	----	----	----



Priključek za peč pod kotom 45°	14	16	18	20
Višina 66 cm				
SAP	177043	177044	177045	177046
EAN	4051921923677	4051921923684	4051921923691	4051921923707
EUR/kos	95,80	104,10	112,30	116,40



Isostatična keramična cev	14	16	18	20
Višina 66 cm, 1,5 kos/m				
SAP	100043	100044	100045	100046
EAN	4037494057445	4037494057452	4037494057469	4037494066171
EUR/kos	26,20	30,50	36,40	37,70



Izolacijske plošče MAT plus	14	16	18	20
1 paket/m				
SAP	100539	100378	100540	100380
EAN	4051921733030	4051921733009	4051921733047	4051921645814
EUR/pkt	23,30	24,80	26,20	27,90



Konzolna plošča	14	16	18	20
SAP	100481	100481	100483	100483
EAN	4037494091234	4037494091234	4037494091241	4037494091241
EUR/kos	53,60	53,60	57,80	57,80



Krovna plošča U	14	16	18	20
Za obzidavo, previs 15 cm				
SAP	103873	103873	103874	103874
EAN	4037494091074	4037494091074	4037494091104	4037494091104
EUR/kos	72,50	72,50	76,80	76,80



Krovna plošča B	14	16	18	20
Za fasadno oblogo, previs 8,5 cm				
SAP	102873	102873	102874	102874
EAN	4037494090954	4037494090954	4037494090961	4037494090961
EUR/kos	72,50	72,50	76,80	76,80

UNI ISO Plus

Enojni Ø 14 - Ø 20 cm

SCHIEDEL
UNI ISO PLUS

→ Svetli premer dimnika	14	16	18	20
-------------------------	----	----	----	----

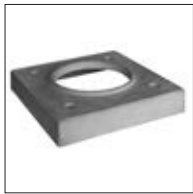

Krovna plošča FINAL	14	16	18	20
Previs 2,5 cm				
SAP	118042	118042	118355	118355
EAN	4037494443507	4037494443507	4037494443514	4037494443514
EUR/kos	43,40	43,40	50,80	50,80



Pritrdilni set za krovno ploščo	14	16	18	20
SAP		102003		
EAN		4037494055502		
EUR/kos		22,00		



Paket omega zaključka UNI ISO plus	14	16	18	20
Vsebina: distančna rozeta, omega zaključek, tesnilni kit.				
SAP	135704	135705	135706	135707
EAN	4051921574848	4051921574855	4051921574862	4051921574879
EUR/kos	112,80	112,80	121,40	121,40



Paket konusnega zaključka UNI ISO plus	14	16	18	20
Vsebina: konusni nastavek, dimna cev 33 cm, tesnilni kit, pokrov proti padavinam.				
SAP	135712	135713	135714	135715
EAN	4051921574923	4051921574930	4051921574947	4051921574954
EUR/kos	131,50	141,70	154,70	189,30



Malta za zidanje plaščev 25 kg	14	16	18	20
SAP	132348	132348	132348	132348
EAN	3831054716657	3831054716657	3831054716657	3831054716657
EUR/kos	11,70	11,70	11,70	11,70
Poraba kg/m	5	5,5	6	6,5

Pomembno:

■ Preverite našo tehnično dokumentacijo (slike so simbolične).

UNI ISO Plus

Enojni z ventilacijo Ø 14 - Ø 20 cm

SCHIEDEL
UNI ISO PLUS

→ Svetli premer dimnika	14L	16L	18L	20L
-------------------------	-----	-----	-----	-----



Dimnik UNI ISO plus EZL	Tip	UNI plus 14L	UNI plus 16L	UNI plus 18L	UNI plus 20L
	Zunanja mera	32/46	32/46	36/50	36/50
	Teža kg/m	91	91	104	106



Dimniški plašč		14L	16L	18L	20L
Višina 33 cm, 3 kos/m	SAP	100361	100361	100363	100363
	EAN	4037494089941	4037494089941	4037494089958	4037494089958
	EUR/kos	19,10	19,10	20,40	20,40



Podstavek kondenzne posode UNI ISO plus		14	16	18	20
Višina 16,6 cm	SAP	132557	132557	132557	132557
	EAN	3831054740867	3831054740867	3831054740867	3831054740867
	EUR/kos	17,60	17,60	17,60	17,60

+



Osnovni paket UNI ISO plus		14	16	18	20
Vsebina: kondenzna posoda z odvodom, notranje zapiralo vratc G, dimniška vratca, ventilacijska rešetka, šablona za maltanje, izolacijske plošče za RA priključek, zaščitni karton in obroč za ometavanje, ognjeobstojno lepilo rapid v kartuši (3 kos), pištola za kartuše, navodilo za montažo.	SAP	135700	135701	135702	135703
	EAN	4051921574800	4051921574817	4051921574824	4051921574831
	EUR/kos	186,40	191,90	206,40	215,20



Priključek za dimniška vratca		14	16	18	20
Višina 33 cm	SAP	102122	102123	102124	102125
	EAN	4037494137390	4037494142233	4037494119044	4037494168097
	EUR/kos	49,30	52,20	66,50	68,10



Priključek za peč pod kotom 90°		14	16	18	20
Višina 33 cm	SAP	102025	102109	102110	102111
	EAN	4037494066027	4037494142226	4037494119051	4037494168080
	EUR/kos	45,00	47,70	60,90	62,10

Tehnične spremembe pridržane. Veljavnost cenika od 20. 3. 2024 do preklica.

UNI ISO Plus

Enojni z ventilacijo Ø 14 - Ø 20 cm

SCHIEDEL

UNI ISO PLUS

→ Svetli premer dimnika 14L 16L 18L 20L

Prikluček za peč pod kotom 45°

Višina 66 cm

	14	16	18	20
SAP	177043	177044	177045	177046
EAN	4051921923677	4051921923684	4051921923691	4051921923707
EUR/kos	95,80	104,10	112,30	116,40

Isostatična keramična cev

Višina 66 cm, 1,5 kos/m

	14	16	18	20
SAP	100043	100044	100045	100046
EAN	4037494057445	4037494057452	4037494057469	4037494066171
EUR/kos	26,20	30,50	36,40	37,70

Izolacijske plošče MAT plus

1 paket/m

	14	16	18	20
SAP	100539	100378	100540	100380
EAN	4051921733030	4051921733009	4051921733047	4051921645814
EUR/pkt	23,30	24,80	26,20	27,90

Konzolna plošča

	14L	16L	18L	20L
SAP	100490	100490	100492	100492
EAN	4037494091258	4037494091258	4037494091265	4037494091265
EUR/kos	63,90	63,90	71,00	71,00

Krovna plošča U

Za obzidavo, previs 15 cm

	14L	16L	18L	20L
SAP	103880	103880	103882	103882
EAN	4037494091111	4037494091111	4037494091128	4037494091128
EUR/kos	82,60	82,60	88,10	88,10

Krovna plošča B

Za fasadno oblogo, previs 8,5 cm

	14L	16L	18L	20L
SAP	102402	102402	102404	102404
EAN	4037494802533	4037494802533	4037494802540	4037494802540
EUR/kos	82,60	82,60	88,10	88,10

Pomembno:

■ Preverite našo tehnično dokumentacijo (slike so simbolične).

UNI ISO Plus

Enojni z ventilacijo Ø 14 - Ø 20 cm

SCHIEDEL

UNI ISO PLUS

→ Svetli premer dimnika	14L	16L	18L	20L
-------------------------	-----	-----	-----	-----

Krovna plošča FINAL

Previs 2,5 cm

	14L	16L	18L	20L
SAP	118121	118121	118416	118416
EAN	4037494443781	4037494443781	4037494443798	4037494443798
EUR/kos	57,80	57,80	65,10	65,10

Pritrdilni set za krovno ploščo

SAP	102003
EAN	4037494055502
EUR/kos	22,00

**Paket omega zaključka
UNI ISO plus**

	14L	16L	18L	20L
SAP	135708	135709	135710	135711
EAN	4051921574886	4051921574893	4051921574909	4051921574916
EUR/kos	115,60	115,60	125,60	125,60

**Paket konusnega zaključka
UNI ISO plus**

Vsebina: konusni nastavek, dimna cev 33 cm, tesnilni kit, pokrov proti padavinam.

	14	16	18	20
SAP	135712	135713	135714	135715
EAN	4051921574923	4051921574930	4051921574947	4051921574954
EUR/kos	131,50	141,70	154,70	189,30

Malta za zidanje plaščev 25 kg

	14	16	18	20
SAP	132348	132348	132348	132348
EAN	3831054716657	3831054716657	3831054716657	3831054716657
EUR/kos	11,70	11,70	11,70	11,70
Poraba kg/m	5	5,5	6	6,5

UNI ISO Plus

Dvojni Ø 14 - Ø 20 cm

SCHIEDEL
UNI ISO PLUS

→ Svetli premer dimnika	14/14	16/16	18/18	20/20
-------------------------	-------	-------	-------	-------



Dimnik UNI ISO plus ZZ	Tip	UNI plus 1414	UNI plus 1616	UNI plus 1818	UNI plus 2020
	Zunanja mera	32/59	32/59	36/67	36/67
	Teža kg/m	111	111	129	132



Dimniški plašč		14/14	16/16	18/18	20/20
Višina 33 cm, 3 kos/m	SAP	100352	100352	100355	100355
	EAN	4037494089965	4037494089965	4037494089972	4037494089972
	EUR/kos	22,00	22,00	26,20	26,20



Podstavek kondenzne posode UNI ISO plus		14	16	18	20
Višina 16,6 cm	SAP	132557	132557	132557	132557
	EAN	3831054740867	3831054740867	3831054740867	3831054740867
	EUR/kos	17,60	17,60	17,60	17,60

+

Osnovni paket UNI ISO plus		14	16	18	20
Vsebina: kondenzna posoda z odvodom, notranje zapiralo vratc G, dimniška vratca, ventilacijska rešetka, šablona za maltanje, izolacijske plošče za RA priključek, zaščitni karton in obroč za ometavanje, ognjeobstojno lepilo rapid v kartuši (3 kos), pištola za kartuše, navodilo za montažo.	SAP	135700	135701	135702	135703
	EAN	4051921574800	4051921574817	4051921574824	4051921574831
	EUR/kos	186,40	191,90	206,40	215,20



Priključek za dimniška vratca		14	16	18	20
Višina 33 cm	SAP	102122	102123	102124	102125
	EAN	4037494137390	4037494142233	4037494119044	4037494168097
	EUR/kos	49,30	52,20	66,50	68,10



Priključek za peč pod kotom 90°		14	16	18	20
Višina 33 cm	SAP	102025	102109	102110	102111
	EAN	4037494066027	4037494142226	4037494119051	4037494168080
	EUR/kos	45,00	47,70	60,90	62,10

Pomembno:

■ Preverite našo tehnično dokumentacijo (slike so simbolične).

UNI ISO Plus

Dvojni Ø 14 - Ø 20 cm

SCHIEDEL

UNI ISO PLUS

→ Svetli premer dimnika	14/14	16/16	18/18	20/20
-------------------------	-------	-------	-------	-------



Priključek za peč pod kotom 45°	14	16	18	20
Višina 66 cm				
SAP	177043	177044	177045	177046
EAN	4051921923677	4051921923684	4051921923691	4051921923707
EUR/kos	95,80	104,10	112,30	116,40



Isostatična keramična cev	14	16	18	20
Višina 66 cm, 1,5 kos/m				
SAP	100043	100044	100045	100046
EAN	4037494057445	4037494057452	4037494057469	4037494066171
EUR/kos	26,20	30,50	36,40	37,70



Izolacijske plošče MAT plus	14	16	18	20
1 paket/m				
SAP	100539	100378	100540	100380
EAN	4051921733030	4051921733009	4051921733047	4051921645814
EUR/pkt	23,30	24,80	26,20	27,90



Konzolna plošča	14/14	16/16	18/18	20/20
SAP	100482	100482	100485	100485
EAN	4037494091272	4037494091272	4037494091289	4037494091289
EUR/kos	95,40	95,40	105,50	105,50



Krovna plošča U	14/14	16/16	18/18	20/20
Za obzidavo, previs 15 cm				
SAP	102896	102896	103876	103876
EAN	4037494091135	4037494091135	4037494091142	4037494091142
EUR/kos	92,60	92,60	102,60	102,60



Krovna plošča B	14/14	16/16	18/18	20/20
Za fasadno oblogo, previs 8,5 cm				
SAP	102399	102399	102401	102401
EAN	4037494802502	4037494802502	4037494802519	4037494802519
EUR/kos	92,60	92,60	102,60	102,60

UNI ISO Plus

Dvojni Ø 14 - Ø 20 cm

SCHIEDEL
UNI ISO PLUS

→ Svetli premer dimnika	14/14	16/16	18/18	20/20
-------------------------	-------	-------	-------	-------



Krovna plošča FINAL		18/20	20/20
Previs 2,5 cm			
SAP		113882	113882
EAN		4037494443675	4037494443675
EUR/kos		65,10	65,10



Pritrdilni set za krovno ploščo			
SAP		102003	
EAN		4037494055502	
EUR/kos		22,00	



Malta za zidanje plašcev 25 kg	14/14	16/16	18/18	20/20
SAP	132348	132348	132348	132348
EAN	3831054716657	3831054716657	3831054716657	3831054716657
EUR/kos	11,70	11,70	11,70	11,70
Poraba kg/m	5	5,5	6	6,5



Dilatacijska rozeta UNI ISO plus	14	16	18	20
2 kos/dimnik				
V primeru zaključka brez konusnega nastavka, montira se na krovno ploščo.				
SAP	132605	132606	132607	132430
EAN	3831054726687	3831054726694	3831054726700	3831054726717
EUR/kos	32,20	32,20	39,10	39,10



Silikonski kit			
SAP		102525	
EAN		4037494005750	
EUR/kos		13,20	



Omega zaključek	Tip (dvojni)	E Ø 14-14	F Ø 18-18
SAP		135365	135366
EAN		4051921574541	4051921574558
EUR/kos		80,80	82,60

Pomembno:

- Preverite našo tehnično dokumentacijo (slike so simbolične).

UNI ISO Plus

Dvojni z ventilacijo Ø 14 - Ø 20 cm

SCHIEDEL
UNI ISO PLUS

→ Svetli premer dimnika 14/L/14 16/L/16 18/L/18 20/L/20



Dimnik UNI ISO plus ZZZ	Tip	UNI plus 14L14	UNI plus 16L16	UNI plus 18L18	UNI plus 20L20
	Zunanja mera	32/72	32/72	36/83	36/83
	Teža kg/m	135	135	158	161



Dimniški plašč		14/14	16/16	18/18	20/20
Višina 33 cm, 3 kos/m	SAP	100362	100362	100365	100365
	EAN	4037494089989	4037494089989	4037494089996	4037494089996
	EUR/kos	26,20	26,20	32,20	32,20



Podstavek kondenzne posode UNI ISO plus		14	16	18	20
Višina 16,6 cm	SAP	132557	132557	132557	132557
	EAN	3831054740867	3831054740867	3831054740867	3831054740867
	EUR/kos	17,60	17,60	17,60	17,60

+



Osnovni paket UNI ISO plus		14	16	18	20
Vsebina: kondenzna posoda z odvodom, notranje zapiralo vratc G, dimniška vratca, ventilacijska rešetka, šablona za maltnje, izolacijske plošče za RA priključek, zaščitni karton in obroč za ometavanje, ognjeobstojno lepilo rapid v kartuši (3 kos), pištola za kartuše, navodilo za montažo.	SAP	135700	135701	135702	135703
	EAN	4051921574800	4051921574817	4051921574824	4051921574831
	EUR/kos	186,40	191,90	206,40	215,20



Priključek za dimniška vratca		14	16	18	20
Višina 33 cm	SAP	102122	102123	102124	102125
	EAN	4037494137390	4037494142233	4037494119044	4037494168097
	EUR/kos	49,30	52,20	66,50	68,10



Priključek za peč pod kotom 90°		14	16	18	20
Višina 33 cm	SAP	102025	102109	102110	102111
	EAN	4037494066027	4037494142226	4037494119051	4037494168080
	EUR/kos	45,00	47,70	60,90	62,10

Tehnične spremembe pridržane. Veljavnost cenika od 20. 3. 2024 do preklica.

UNI ISO Plus

Dvojni z ventilacijo Ø 14 - Ø 20 cm

SCHIEDEL

UNI ISO PLUS

→ Svetli premer dimnika 14/L/14 16/L/16 18/L/18 20/L/20



Priključek za peč pod kotom 45° Višina 66 cm	14	16	18	20
SAP	177043	177044	177045	177046
EAN	4051921923677	4051921923684	4051921923691	4051921923707
EUR/kos	95,80	104,10	112,30	116,40



Isostatična keramična cev Višina 66 cm, 1,5 kos/m	14	16	18	20
SAP	100043	100044	100045	100046
EAN	4037494057445	4037494057452	4037494057469	4037494066171
EUR/kos	26,20	30,50	36,40	37,70



Izolacijske plošče MAT plus 1 paket/m	14	16	18	20
SAP	100539	100378	100540	100380
EAN	4051921733030	4051921733009	4051921733047	4051921645814
EUR/pkt	23,30	24,80	26,20	27,90



Konzolna plošča	14/L/14	16/L/16	18/L/18	20/L/20
SAP	100491	100491	100494	100494
EAN	4037494091296	4037494091296	4037494091302	4037494091302
EUR/kos	109,70	109,70	115,60	115,60



Krovna plošča U Za obzidavo, previs 15 cm	14/L/14	16/L/16	18/L/18	20/L/20
SAP	103881	103881	103884	103884
EAN	4037494091159	4037494091159	4037494091166	4037494091166
EUR/kos	93,90	93,90	101,20	101,20



Krovna plošča B Za fasadno oblogo, previs 8,5 cm	14/L/14	16/L/16	18/L/18	20/L/20
SAP	132473	132473	102406	102406
EAN	3831054749402	3831054749402	4037494802595	4037494802595
EUR/kos	93,90	93,90	101,20	101,20

Pomembno:

■ Preverite našo tehnično dokumentacijo (slike so simbolične).

UNI ISO Plus

Dvojni z ventilacijo Ø 14 - Ø 20 cm

SCHIEDEL

UNI ISO PLUS

→ Svetli premer dimnika 14/L/14 16/L/16 18/L/18 20/L/20

Pritrdilni set za krovno ploščo

SAP	102003			
EAN	4037494055502			
EUR/kos	22,00			

Malta za zidanje plaščev 25 kg

	14/14	16/16	18/18	20/20
SAP	132348	132348	132348	132348
EAN	3831054716657	3831054716657	3831054716657	3831054716657
EUR/kos	11,70	11,70	11,70	11,70
Poraba kg/m	5	5,5	6	6,5

Dilatacijska rozeta UNI ISO plus

2 kos/dimnik
V primeru zaključka brez konusnega nastavka, montira se na krovno ploščo.

	14	16	18	20
SAP	132605	132606	132607	132430
EAN	3831054726687	3831054726694	3831054726700	3831054726717
EUR/kos	32,20	32,20	39,10	39,10

Silikonski kit

SAP	102525			
EAN	4037494005750			
EUR/kos	13,20			

Omega zaključek

	Tip (dvojni)	G Ø 1414 L	H Ø 1818 L
SAP		135367	135368
EAN		4051921574565	4051921574572
EUR/kos		88,10	91,10

UNI ISO Plus

Dvojni kombinirani Ø 14 - Ø 20 cm

SCHIEDEL
UNI ISO PLUS

→ Svetli premer dimnika	18/14	18/16	20/14	20/16
-------------------------	-------	-------	-------	-------



Dimnik UNI ISO plus ZZK	Tip	UNI plus 1814	UNI plus 1816	UNI plus 2014	UNI plus 2016
	Zunanja mera	36/64	36/64	36/64	36/64
	Teža kg/m	132	132	134	136



Dimniški plašč		18/14	18/16	20/14	20/16
Višina 33 cm, 3 kos/m	SAP	100354	100354	100354	100354
	EAN	4037494090008	4037494090008	4037494090008	4037494090008
	EUR/kos	26,20	26,20	26,20	26,20



Podstavek kondenzne posode UNI ISO plus		14	16	18	20
Višina 16,6 cm	SAP	132557	132557	132557	132557
	EAN	3831054740867	3831054740867	3831054740867	3831054740867
	EUR/kos	17,60	17,60	17,60	17,60

+

Osnovni paket UNI ISO plus		18	18	20	20
Vsebina: kondenzna posoda z odvodom, notranje zapiralo vratc G, dimniška vratca, ventilacijska rešetka, šablona za maltanje, izolacijske plošče za RA priključek, zaščitni karton in obroč za ometavanje, ognjeobstojno lepilo rapid v kartuši (3 kos), pištola za kartuše, navodilo za montažo.	SAP	135702	135702	135703	135703
	EAN	4051921574824	4051921574824	4051921574831	4051921574831
	EUR/kos	206,40	206,40	215,20	215,20
		14	16	14	16
	SAP	135700	135701	135700	135701
	EAN	4051921574800	4051921574817	4051921574800	4051921574817
	EUR/kos	186,40	191,90	186,40	191,90



Priključek za dimniška vratca		18	18	20	20
Višina 33 cm	SAP	102124	102124	102125	102125
	EAN	4037494119044	4037494119044	4037494168097	4037494168097
	EUR/kos	66,50	66,50	68,10	68,10
		14	16	14	16
	SAP	102122	102123	102122	102123
	EAN	4037494137390	4037494142233	4037494137390	4037494142233
	EUR/kos	49,30	52,20	49,30	52,20



Priključek za peč pod kotom 90°		18	18	20	20
Višina 33 cm	SAP	102110	102110	102111	102111
	EAN	4037494119051	4037494119051	4037494168080	4037494168080
	EUR/kos	60,90	60,90	62,10	62,10
		14	16	14	16
	SAP	102025	102109	102025	102109
	EAN	4037494066027	4037494142226	4037494066027	4037494142226
	EUR/kos	45,00	47,70	45,00	47,70

Pomembno:

- Preverite našo tehnično dokumentacijo (slike so simbolične).

UNI ISO Plus

Dvojni kombinirani Ø 14 - Ø 20 cm

SCHIEDEL

UNI ISO PLUS

→ Svetli premer dimnika	18/14	18/16	20/14	20/16
-------------------------	-------	-------	-------	-------



Priključek za peč pod kotom 45°	18	18	20	20
Višina 66 cm				
SAP	177045	177045	177046	177046
EAN	4051921923691	4051921923691	4051921923707	4051921923707
EUR/kos	112,30	112,30	116,40	116,40
	14	16	14	16
SAP	177043	177044	177043	177044
EAN	4051921923677	4051921923684	4051921923677	4051921923684
EUR/kos	95,80	104,10	95,80	104,10



Isostatična keramična cev	18	18	20	20
Višina 66 cm, 1,5 kos/m				
SAP	100045	100045	100046	100046
EAN	4037494057469	4037494057469	4037494066171	4037494066171
EUR/kos	36,40	36,40	37,70	37,70
	14	16	14	16
SAP	100043	100044	100043	100044
EAN	4037494057445	4037494057452	4037494057445	4037494057452
EUR/kos	26,20	30,50	26,20	30,50



Izolacijske plošče MAT plus	18	18	20	20
1 paket/m				
SAP	100540	100540	100380	100380
EAN	4051921733047	4051921733047	4051921645814	4051921645814
EUR/pkt	26,20	26,20	27,90	27,90
	14	16	14	16
SAP	100539	100378	100539	100378
EAN	4051921733030	4051921733009	4051921733030	4051921733009
EUR/pkt	23,30	24,80	23,30	24,80



Konzolna plošča	18/14	18/16	20/14	20/16
SAP	100484	100484	100484	100484
EAN	4037494091319	4037494091319	4037494091319	4037494091319
EUR/kos	109,70	109,70	109,70	109,70



Krovna plošča U	18/14	18/16	20/14	20/16
Za obzidavo, previs 15 cm				
SAP	103875	103875	103875	103875
EAN	4037494091173	4037494091173	4037494091173	4037494091173
EUR/kos	122,90	122,90	122,90	122,90



Krovna plošča B	18/14	18/16	20/14	20/16
Za fasadno oblogo, previs 8,5 cm				
SAP	102400	102400	102400	102400
EAN	4037494802526	4037494802526	4037494802526	4037494802526
EUR/kos	122,90	122,90	122,90	122,90

UNI ISO Plus

Dvojni kombinirani Ø 14 - Ø 20 cm

SCHIEDEL

UNI ISO PLUS

→ Svetli premer dimnika	18/14	18/16	20/14	20/16
-------------------------	-------	-------	-------	-------

Krovna plošča FINAL

Previs 2,5 cm

	18/14	18/16	20/14	20/16
SAP	123625	123625	123625	123625
EAN	4037494952337	4037494952337	4037494952337	4037494952337
EUR/kos	65,10	65,10	65,10	65,10

Pritrdilni set za krovno ploščo

SAP	102003
EAN	4037494055502
EUR/kos	21,30

Malta za zidanje plaščev 25 kg

	18/14	18/16	20/14	20/16
SAP	132348	132348	132348	132348
EAN	3831054716657	3831054716657	3831054716657	3831054716657
EUR/kos	11,70	11,70	11,70	11,70
Poraba kg/m	5	5,5	6	6,5

Dilatacijska rozeta UNI ISO plus

2 kos/dimnik

V primeru zaključka brez konusnega nastavka, montira se na krovno ploščo.

	14	16	18	20
SAP	132605	132606	132607	132430
EAN	3831054726687	3831054726694	3831054726700	3831054726717
EUR/kos	32,20	32,20	39,10	39,10

Silikonski kit

SAP	102525
EAN	4037494005750
EUR/kos	13,20

Omega zaključek

Tip (dvojni)	I Ø 1418
SAP	135369
EAN	4051921574589
EUR/kos	96,90

Pomembno:

■ Preverite našo tehnično dokumentacijo (slike so simbolične).

UNI ISO Plus

Dvojni kombinirani z ventilacijo

Ø 14 - Ø 20 cm

SCHIEDEL
UNI ISO PLUS

→ Svetli premer dimnika	18/L/14	18/L/16	20/L/14	20/L/16
-------------------------	---------	---------	---------	---------



Dimnik UNI ISO plus ZZLK	Tip	UNI plus 18L14	UNI plus 18L16	UNI plus 20L14	UNI plus 20L16
Zunanja mera		36/81	36/81	36/81	36/81
Teža kg/m		162	162	164	165



Dimniški plašč		18/L/14	18/L/16	20/L/14	20/L/16
Višina 33 cm, 3 kos/m	SAP	100364	100364	100364	100364
	EAN	4037494090015	4037494090015	4037494090015	4037494090015
	EUR/kos	32,20	32,20	32,20	32,20



Podstavek kondenzne posode UNI ISO plus		14	16	18	20
Višina 16,6 cm	SAP	132557	132557	132557	132557
	EAN	3831054740867	3831054740867	3831054740867	3831054740867
	EUR/kos	17,60	17,60	17,60	17,60

+

Osnovni paket UNI ISO plus		18	18	20	20
Vsebina: kondenzna posoda z odvodom, notranje zapiralo vratc G, dimniška vratca, ventilacijska rešetka, šablona za maltnje, izolacijske plošče za RA priključek, zaščitni karton in obroč za ometavanje, ognjeobstojno lepilo rapid v kartuši (3 kos), pištola za kartuše, navodilo za montažo.	SAP	135702	135702	135703	135703
	EAN	4051921574824	4051921574824	4051921574831	4051921574831
	EUR/kos	206,40	206,40	215,20	215,20
		14	16	14	16
	SAP	135700	135701	135700	135701
	EAN	4051921574800	4051921574817	4051921574800	4051921574817
	EUR/kos	186,40	191,90	186,40	191,90



Priključek za dimniška vratca		18	18	20	20
Višina 33 cm	SAP	102124	102124	102125	102125
	EAN	4037494119044	4037494119044	4037494168097	4037494168097
	EUR/kos	66,50	66,50	68,10	68,10
		14	16	14	16
	SAP	102122	102123	102122	102123
	EAN	4037494137390	4037494142233	4037494137390	4037494142233
	EUR/kos	49,30	52,20	49,30	52,20



Priključek za peč pod kotom 90°		18	18	20	20
Višina 33 cm	SAP	102110	102110	102111	102111
	EAN	4037494119051	4037494119051	4037494168080	4037494168080
	EUR/kos	60,90	60,90	62,10	62,10
		14	16	14	16
	SAP	102025	102109	102025	102109
	EAN	4037494066027	4037494142226	4037494066027	4037494142226
	EUR/kos	45,00	47,70	45,00	47,70

Tehnične spremembe pridržane. Veljavnost cenika od 20. 3. 2024 do preklica.

UNI ISO Plus

Dvojni kombinirani z ventilacijo

Ø 14 - Ø 20 cm

SCHIEDEL
UNI ISO PLUS

→ Svetli premer dimnika	18/L/14	18/L/16	20/L/14	20/L/16
-------------------------	---------	---------	---------	---------



Prikluček za peč pod kotom 45° Višina 66 cm	18	18	20	20
SAP	177045	177045	177046	177046
EAN	4051921923691	4051921923691	4051921923707	4051921923707
EUR/kos	112,30	112,30	116,40	116,40
	14	16	14	16
SAP	177043	177044	177043	177044
EAN	4051921923677	4051921923684	4051921923677	4051921923684
EUR/kos	95,80	104,10	95,80	104,10



Isostatična keramična cev Višina 66 cm, 1,5 kos/m	18	18	20	20
SAP	100045	100045	100046	100046
EAN	4037494057469	4037494057469	4037494066171	4037494066171
EUR/kos	36,40	36,40	37,70	37,70
	14	16	14	16
SAP	100043	100044	100043	100044
EAN	4037494057445	4037494057452	4037494057445	4037494057452
EUR/kos	26,20	30,50	26,20	30,50



Izolacijske plošče MAT plus 1 paket/m	18	18	20	20
SAP	100540	100540	100380	100380
EAN	4051921733047	4051921733047	4051921645814	4051921645814
EUR/pkt	26,20	26,20	27,90	27,90
	14	16	14	16
SAP	100539	100378	100539	100378
EAN	4051921733030	4051921733009	4051921733030	4051921733009
EUR/pkt	23,30	24,80	23,30	24,80



Konzolna plošča	18/L/14	18/L/16	20/L/14	20/L/16
SAP	100493	100493	100493	100493
EAN	4037494091326	4037494091326	4037494091326	4037494091326
EUR/kos	115,60	115,60	115,60	115,60



Krovna plošča U Za obzidavo, previs 15 cm	18/L/14	18/L/16	20/L/14	20/L/16
SAP	103883	103883	103883	103883
EAN	4037494091180	4037494091180	4037494091180	4037494091180
EUR/kos	131,50	131,50	131,50	131,50



Krovna plošča B Za fasadno oblogo, previs 8,5 cm	18/L/14	18/L/16	20/L/14	20/L/16
SAP	102405	102405	102405	102405
EAN	4037494802601	4037494802601	4037494802601	4037494802601
EUR/kos	131,50	131,50	131,50	131,50

Pomembno:

■ Preverite našo tehnično dokumentacijo (slike so simbolične).

UNI ISO Plus

Dvojni kombinirani z ventilacijo

Ø 14 - Ø 20 cm

SCHIEDEL

UNI ISO PLUS

Svetli premer dimnika	18/L/14	18/L/16	20/L/14	20/L/16
-----------------------	---------	---------	---------	---------



Krovna plošča FINAL	18/L/14	18/L/16	20/L/14	20/L/16
Previs 2,5 cm				
SAP	113808	113808	113808	113808
EAN	4037494443668	4037494443668	4037494443668	4037494443668
EUR/kos	65,10	65,10	65,10	65,10



Pritrdilni set za krovno ploščo				
SAP		102003		
EAN		4037494055502		
EUR/kos		22,00		



Malta za zidanje plaščev 25 kg	18/14	18/16	20/14	20/16
SAP	132348	132348	132348	132348
EAN	3831054716657	3831054716657	3831054716657	3831054716657
EUR/kos	11,70	11,70	11,70	11,70
Poraba kg/m	5	5,5	6	6,5



Dilatacijska rozeta UNI ISO plus	14	16	18	20
2 kos/dimnik				
V primeru zaključka brez konusnega nastavka, montira se na krovno ploščo.				
SAP	132605	132606	132607	132430
EAN	3831054726687	3831054726694	3831054726700	3831054726717
EUR/kos	32,20	32,20	39,10	39,10



Silikonski kit				
SAP		102525		
EAN		4037494005750		
EUR/kos		13,20		



Omega zaključek	Tip (dvojni)	J Ø 1418 L
SAP		135370
EAN		4051921574596
EUR/kos		100,10

UNI ISO Plus

Seti

SCHIEDEL
UNI ISO PLUS



Vsebina: dimniški plašči, dimne cevi, priključek za vratca, priključek za peč, izolacijske plošče, podstavek kondenzne posode, kondenzna posoda z odvodom, malta za zidanje plaščev, osnovni paket.

Svetli Ø UNI ISO plus dimnika	14	16	18	20
-------------------------------	----	----	----	----

Enojni Ø 14 - Ø 20 cm UNI ISO plus SET- začetni 3,00 m	14	16	18	20
SAP	135680	135681	135682	135683
EAN	4051921574602	4051921574619	4051921574626	4051921574633
EUR/pkt	556,80	582,70	660,70	679,30

Vsebina: dimniški plašči (9 kos), keramične cevi (3 kos, 66 cm), priključek za vratca (1 kos, 33 cm), priključek za peč (1 kos, 33 cm), izolacijske plošče MAT plus (3 paketi), podstavek kondenzne posode (1 kos), kondenzna posoda z odvodom (1 kos), osnovni paket (1 kos), malta za zidanje plaščev (1 kos).

Svetli Ø UNI ISO plus dimnika	14L	16L	18L	20L
-------------------------------	-----	-----	-----	-----

Enojni z ventilacijo Ø 14 - Ø 20 cm UNI ISO plus SET- začetni 3,00 m	14L	16L	18L	20L
SAP	135686	135687	135688	135689
EAN	4051921574664	4051921574671	4051921574688	4051921574695
EUR/pkt	569,70	605,80	673,80	702,50

Vsebina: dimniški plašči (9 kos), keramične cevi (3 kos, 66 cm), priključek za vratca (1 kos, 33 cm), priključek za peč (1 kos, 33 cm), izolacijske plošče MAT plus (3 paketi), podstavek kondenzne posode (1 kos), kondenzna posoda z odvodom (1 kos), osnovni paket (1 kos), malta za zidanje plaščev (1 kos).

Enojni Ø 20 cm UNI ISO plus SET- začetni Ø 18 - Ø 20 cm 3,00 m (RA 45°)	14	16	18	20
SAP	-	-	135684	135685
EAN	-	-	4051921574640	4051921574657
EUR/pkt	-	-	660,70	679,30

Vsebina: dimniški plašči (9 kos), keramične cevi (2 kos, 66 cm), keramična cev (1 kos, 33cm), priključek za vratca (1 kos, 33 cm), priključek za peč (1 kos, 66 cm), izolacijske plošče MAT plus (3 paketi), podstavek kondenzne posode (1 kos), kondenzna posoda z odvodom (1 kos), osnovni paket (1 kos), malta za zidanje plaščev (1 kos).

Enojni z ventilacijo Ø 18 - Ø 20 cm UNI ISO plus SET- začetni 3,00 m (RA 45°)	14L	16L	18L	20L
SAP	-	-	135690	135691
EAN	-	-	4051921574701	4051921574718
EUR/pkt	-	-	692,40	712,60

Vsebina: dimniški plašči (9 kos), keramične cevi (2 kos, 66 cm), keramična cev (1 kos, 33cm), priključek za vratca (1 kos, 33 cm), priključek za peč (1 kos, 66 cm), izolacijske plošče MAT plus (3 paketi), podstavek kondenzne posode (1 kos), kondenzna posoda z odvodom (1 kos), osnovni paket (1 kos), malta za zidanje plaščev (1 kos).

Enojni Ø 16 - Ø 20 cm UNI ISO plus SET - dimnik 6,00 m	14	16	18	20
SAP	-	168532	168533	168534
EAN	-	4051921823618	4051921823625	4051921823632
EUR/pkt	-	904,40	1025,50	1055,70

Vsebina: dimniški plašči (18 kos), keramične cevi (9 kos, 66 cm), priključek za vratca (1 kos, 33 cm), priključek za peč (1 kos, 66 cm), izolacijske plošče MAT plus (6 paketov), podstavek kondenzne posode (1 kos), kondenzna posoda z odvodom (1 kos), osnovni paket (1 kos).

Enojni Ø 16 - Ø 20 cm UNI ISO plus SET - dimnik 6,00 m (RA 45°)	14	16	18	20
SAP	-	-	168535	168536
EAN	-	-	4051921823649	4051921823656
EUR/pkt	-	-	1049,90	1090,30

Vsebina: dimniški plašči (18 kos), keramične cevi (9 kos, 66 cm), priključek za vratca (1 kos, 33 cm), priključek za peč (1 kos, 66 cm), izolacijske plošče MAT plus (6 paketov), podstavek kondenzne posode (1 kos), kondenzna posoda z odvodom (1 kos), osnovni paket (1 kos).

Pomembno:

- Preverite našo tehnično dokumentacijo (slike so simbolične).

→ Svetli premer dimnika	14	16	18	20
-------------------------	----	----	----	----



Isostatična keramična cev	14	16	18	20
Višina 33 cm, 3 kos/m				
SAP	101992	102042	102043	102044
EAN	4037494065662	4037494142219	4037494119075	4037494167717
EUR/kos	20,40	24,80	29,10	29,10



Paket priključka za vratca UNI ISO plus za suho delovanje G - DODATEN	14	16	18	20
Vsebina: priključek za vratca višine 33 cm, dimniška vratca, notranje zapiralo za vratca G.				
SAP	135716	135717	135718	135719
EAN	4051921574961	4051921574978	4051921574985	4051921574992
EUR/kos	121,40	122,90	137,30	140,20



Paket priključka za peč 90° UNI ISO plus - DODATEN	14	16	18	20
Vsebina: priključek za peč višine 33 cm, vložek - izolacija (2 kos), nosilec izolacije (4 kos), zaščitni obroč za ometavanje, zaščitni karton, vrečka z žeblički.				
SAP	-	135721	135722	135723
EAN	-	4051921575012	4051921575029	4051921575036
EUR/kos	-	62,10	79,60	80,80



Paket za naknadno izdelavo priključka za vratca UNI ISO plus	14	16	18	20
Vsebina: nos priključka za vratca, notranje zapiralo vratca G, vratca PT III, ognjeobstojno lepilo, navodilo za montažo.				
SAP	-	135725	135726	135727
EAN	-	4051921575050	4051921575067	4051921575074
EUR/kos	-	65,10	79,60	80,80



Paket za naknadno izdelavo priključka za peč 90° UNI ISO plus	14	16	18	20
Vsebina: nos priključka za peč, izolacijski plošči za izolacijo priključka, nosilci izolacije, zaščitni obroč za ometavanje, zaščitni kartonast pokrov priključka, vrečka z žeblički, ognjeobstojno lepilo, navodila za montažo.				
SAP	135728	135729	135730	135731
EAN	4051921575081	4051921575098	4051921575104	4051921575111
EUR/kos	92,60	100,10	100,10	104,20



Kondenzna posoda z odvodom	14	16	18	20
SAP	102683	102684	102685	102686
EAN	4037494054581	4037494054598	4037393054604	4037494054611
EUR/kos	47,60	53,60	55,10	62,10

→ Svetli premer dimnika	14	16	18	20
-------------------------	----	----	----	----



Paket za naknadno izdelavo priključka za peč 45°

Vsebina: nos priključka za peč, izolacijski plošči za izolacijo priključka, nosilci izolacije, navodila za montažo.

	14	16	18	20
SAP	-	-	-	135733
EAN	-	-	-	4051921575135
EUR/kos	-	-	-	104,20

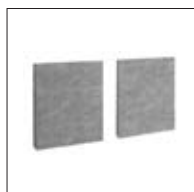

Vložek - izolacija

2 kosa za 1 RA priključek

	14-16	18-20
SAP	132443	132445
EAN	3831054703077	3831054703091
EUR/kos	4,60	4,60



Nosilec izolacije

4 kosi za 1 RA priključek

SAP	132289
EAN	3831054702995
EUR/kos	1,60



Zaščitni set za priključek za peč

Vsebina: izolacijski plošči, nosilci izolacije, zaščitni obroč za ometavanje, zaščitni karton in žbljički za pritrdjevanje.

	14	16	18	20
Šifra	132637	132638	132639	132640
EAN	3831054750156	3831054750163	3831054750170	3831054750187
EUR/kpl	24,80	24,80	24,80	33,80



Ventilacijska vratca

SAP	134110
EAN	4051921541376
EUR/kos	37,70

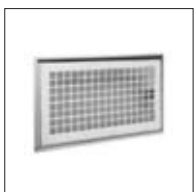

Ventilacijska rešetka

150 x 250 mm

SAP	102681
EAN	4037494090770
EUR/kos	20,40

Pomembno:

- Preverite našo tehnično dokumentacijo (slike so simbolične).

→ Svetli premer dimnika	14	16	18	20
-------------------------	----	----	----	----



Vratca - zunanji del

27 x 37 cm

Ključ za vratca

SAP	102204	900000181
EAN	4049723011227	4037494003992
EUR/kos	52,20	1,60

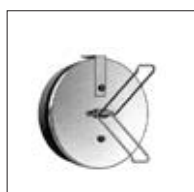
+



Notranje zapiralo vratc G

Za suho delovanje.

14 16 18 20

SAP	101691	101692	101693	101693
EAN	4037494832493	4037494832509	4037494832516	4037494832516
EUR/kos	33,20	23,30	23,30	23,30

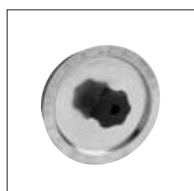
ali

Notranje zapiralo vratc W

Za mokro delovanje.

14 16

SAP	100548	100549	-	-
EAN	4037494011720	4037494011744	-	-
EUR/kos	25,90	28,40	-	-

TEKASIL 300°C

Ognjeobstojni trajno elastični kit 300°C.

SAP	132431
EAN	3831054731803
EUR/kos	14,80

Tesnilni kit Rapid

SAP	100020	100020	100020	100020
EAN	4037494086124	4037494086124	4037494086124	4037494086124
EUR/kos	8,90	8,90	8,90	8,90
Poraba kos/m	0,40	0,40	0,50	0,50

Ognjeobstojno lepilo SPK 1 kg

Za naknadno montažo priključka na peč/vratca.

SAP	102822
EAN	4037494440506
EUR/kos	7,50

→ Svetli premer dimnika	14	16	18	20
-------------------------	----	----	----	----

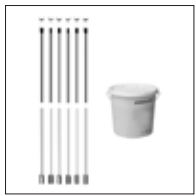

Ojačitveni set in zalivna malta	SET 4 x 4m M12	SET 4 x 6m M12
SAP	133661	133663
EAN	4037494034491	4037494034484
EUR/kos	104,00	146,40



Pritrdilni set za krovno ploščo	
SAP	102003
EAN	4037494055502
EUR/kos	22,00



Konusni nastavek	14	16	18	20
SAP	124335	124336	124337	124338
EAN	4051921447609	4051921447616	4051921447623	4051921447630
EUR/kos	72,50	80,80	86,90	93,90



ABS Pokrov proti padavinam 1218	14	16	18	20
SAP	100234	100234	100234	100235
EAN	4049723004236	4049723004236	4049723004236	4049723004243
EUR/kos	52,20	52,20	52,20	72,50



Pokrov proti padavinam	14	16	18	20
SAP	133788	133790	133791	133792
EAN	4051921478856	4051921478870	4051921478887	4051921478894
EUR/kos	59,10	61,80	70,80	77,40



Dilatacijska rozeta UNI ISO plus	14	16	18	20
V primeru zaključka brez konusnega nastavka, montira se na krovno ploščo.				
SAP	132605	132606	132607	132430
EAN	3831054726687	3831054726694	3831054726700	3831054726717
EUR/kos	32,20	32,20	39,10	39,10

Pomembno:

- Preverite našo tehnično dokumentacijo (slike so simbolične).

→ Svetli premer dimnika	14	16	18	20
-------------------------	----	----	----	----

Dilatacijska rozeta UNI

Montira se pod krovno ploščo.

	14	16	18	20
SAP	132416	132417	132418	132419
EAN	3831054703039	3831054703008	3831054703022	3831054703015
EUR/kos	32,20	32,20	39,10	39,10

Dimna rozeta RA s pokrovom

Podaljšana za šamotne dimnike.

	14	16	18	20
SAP	137409	137410	137411	137412
EAN	4051921589958	4051921589965	4051921589972	4051921589989
EUR/kos	16,10	19,10	26,20	29,10

Keramična vrstica

Dolžina 1,5 m

SAP	175657	100545
EAN	4051921812179	4037494828885
EUR/kos	8,90	22,00
Debelina v cm	0,4	1

Držalo dimnika

SAP	100514
EAN	4037494175088
EUR/kos	221,00

Zaključek Burin

SAP	132599
EAN	3831054766096
EUR/kos	86,90

Betonska krovna plošča

	14	16	18	20
SAP	132580	132583	132586	132589
EAN	3831054765914	3831054765945	3831054765976	3831054766003
EUR/kos	49,30	53,60	57,80	63,90



	Svetli premer dimnika	14	16	18	20
Omega zaključek	Tip (enojni)	A Ø 14/16	B Ø 18/20	C Ø 14/16 L	D Ø 18/20L
	SAP	135361	135362	135363	135364
	EAN	4051921574503	4051921574510	4051921574527	4051921574534
	EUR/kos	66,50	68,10	71,00	72,50
	Tip (dvojni)	E Ø 14-14	F Ø 18-18	G Ø 1414 L	H Ø 1818L
	SAP	135365	135366	135367	135368
	EAN	4051921574541	4051921574558	4051921574565	4051921574572
	EUR/kos	80,80	82,60	88,10	91,10
	Tip (dvojni)	I Ø 1418	J Ø 1418 L		
	SAP	135369	135370		
	EAN	4051921574589	4051921574596		
	EUR/kos	96,90	100,10		



	Svetli premer dimnika	14	16	18	20
Priključni adapter	Ø dim. kanala	8	8		
	SAP	100190	100193		
	EAN	4049723007855	4037494192566		
	EUR/kos	65,10	65,10		
	Ø dim. kanala	10	10		
	SAP	100191	100194		
	EAN	4037494175187	4037494175194		
	EUR/kos	65,10	65,10		
	Ø dim. kanala		12	12	
	SAP		100195	100199	
	EAN		4049723014570	4049723007862	
	EUR/kos		68,10	68,10	
	Ø dim. kanala	13	13	13	
	SAP	100196	100196	100200	
	EAN	4037494175200	4037494175200	4037494175224	
	EUR/kos	73,80	73,80	68,10	
	Ø dim. kanala			15	15
	SAP			100201	100202
	EAN			4037494175231	4037494187531
	EUR/kos			69,50	72,50



Vrečka za kondenz s sklopko	SAP	900014779
	EAN	4051921809360
	EUR/kos	77,40



		115 mm	230 mm
ABS Diamantna rezalka	SAP	101871	101872
	EAN	4037494088746	4037494088753
	EUR/kos	49,30	121,40



		16	18	20
Pokrov šamotni RA	SAP	100332	100333	100334
	EAN	4037494018651	4037494018668	4037494018675
	EUR/kos	10,30	11,70	13,20

Pomembno:

■ Preverite našo tehnično dokumentacijo (slike so simbolične).

→ Schiedel FINAL



Montažni zaključek v imitaciji klasične opečne obzidave. Najcenejša izvedba zaščite dimnika nad streho.



SCHIEDEL
FINAL

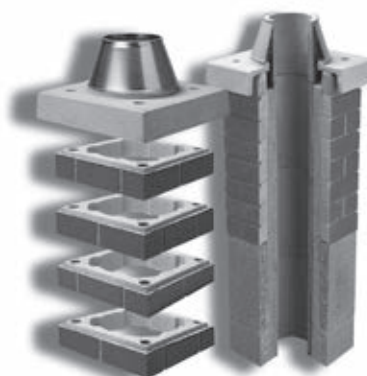

FINAL ELEMENTI

za izvedbo dimiškega zaključka - rdeči

SCHIEDEL
FINAL

Enojni Ø 14 - Ø 20 cm



Svetli Ø UNI plus dimnika	14	16	18	20
---------------------------	----	----	----	----



FINAL element	14	16	18	20
13 kos/m				
SAP	118700	118700	113721	113721
EAN	4051921444776	4051921444776	4051921444783	4051921444783
EUR/kos	11,70	11,70	13,20	13,20
Zunanja mera	34/34	34/34	38/38	38/38
Teža kg/kos	9,70	9,70	11,00	11,00



Krovna plošča FINAL	14	16	18	20
Previs 2,5 cm				
SAP	118042	118042	118355	118355
EAN	4037494443507	4037494443507	4037494443514	4037494443514
EUR/kos	43,40	43,40	50,80	50,80

Enojni Ø 14 - Ø 20 cm



Svetli Ø UNI plus dimnika	14	16	18	20
---------------------------	----	----	----	----



FINAL UNI ISO plus SET - zaključni višine 1,33 m	14	16	18	20
Vsebina: elementi FINAL (17 kos), dimne cevi (2 kos), izolacijske plošče, lepilo za el. FINAL (2 x 5 kg), krovna plošča, zalivna masa ISOTAL (2 x 5 kg), komplet za statično stabilnost (navojne palice (8 x 1 m), pritrdilni set FINAL (4 kos)), ognjeobstojno lepilo rapid v kartuši (1 kos), pištola za kartuše, navodilo za montažo.				
SAP	-	135693	135694	135695
EAN	-	4051921574732	4051921574749	4051921574756
EUR/kpl	-	353,50	357,80	366,50

+



Paket omega zaključka UNI ISO plus	14	16	18	20
Vsebina: distančna rozeta, omega zaključek, tesnilni kit.				
SAP	135704	135705	135706	135707
EAN	4051921574848	4051921574855	4051921574862	4051921574879
EUR/kos	112,80	112,80	121,40	121,40

ali



Paket konusnega zaključka UNI ISO plus	14	16	18	20
Vsebina: konusni nastavek, dimna cev, tesnilna pasta, pokrov proti padavinam.				
SAP	135712	135713	135714	135715
EAN	4051921574923	4051921574930	4051921574947	4051921574954
EUR/kos	131,50	141,70	154,70	189,30

Dodatki (za lepljenje in zagotavljanje statične stabilnosti FINAL zaključka)

	Poraba/dimnik	SAP	EAN	EM	EUR/EM
Pritrdilni komplet FINAL	4	133108	3831054729015	kpl	8,90
Navojna palica M12/1000	8	900003570	4037494850558	kos	4,00
Zalivna masa ISOTAL 5kg	2	132350	3831054729039	kos	7,50
Lepilo KEMAKOL 5kg	2	132347	3831054729046	kos	10,30

Pomembno:

■ Preverite našo tehnično dokumentacijo (slike so simbolične).

FINAL ELEMENTI

za izvedbo dimiškega zaključka - rjavi

SCHIEDEL
FINAL

Enojni Ø 14 - Ø 20 cm



Svetli Ø UNI plus dimnika	14	16	18	20
---------------------------	----	----	----	----



FINAL element 13 kos/m	14	16	18	20
SAP	118701	118701	118702	118702
EAN	4037494448465	4037494448465	4037494448472	4037494448472
EUR/kos	11,70	11,70	13,20	13,20
Zunanja mera	34/34	34/34	38/38	38/38
Teža kg/kos	9,70	9,70	11,00	11,00

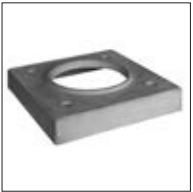

Krovna plošča FINAL Previs 2,5 cm	14	16	18	20
SAP	118042	118042	118355	118355
EAN	4037494443507	4037494443507	4037494443514	4037494443514
EUR/kos	43,40	43,40	50,80	50,80

Enojni Ø 14 - Ø 20 cm



Svetli Ø UNI plus dimnika	14	16	18	20
---------------------------	----	----	----	----



FINAL UNI ISO plus SET - zaključni višine 1,33 m	14	16	18	20
SAP	137101	137102	137103	137104
EAN	4051921575487	4051921575494	4051921575500	4051921575517
EUR/kpl	342,00	353,50	357,80	366,50

Vsebina: elementi FINAL (17 kos), dimne cevi (2 kos), izolacijske plošče, lepilo za el. FINAL (2 x 5 kg), krovna plošča, zalivna masa ISOTAL (2 x 5 kg), komplet za statično stabilnost (navojne palice (8 x 1 m), pritrdilni set FINAL (4 kos)), ognjeobstojno lepilo rapid v kartuši (1 kos), pištola za kartuše, navodilo za montažo.

+



Paket omega zaključka UNI ISO plus	14	16	18	20
SAP	135704	135705	135706	135707
EAN	4051921574848	4051921574855	4051921574862	4051921574879
EUR/kos	112,80	112,80	121,40	121,40

Vsebina: distančna rozeta, omega zaključek, tesnilni kit.

ali



Paket konusnega zaključka UNI ISO plus	14	16	18	20
SAP	135712	135713	135714	135715
EAN	4051921574923	4051921574930	4051921574947	4051921574954
EUR/kos	131,50	141,70	154,70	189,30

Vsebina: konusni nastavek, dimna cev, tesnilna pasta, pokrov proti padavinam.

Dodatki (za lepljenje in zagotavljanje statične stabilnosti FINAL zaključka)

	Poraba/dimnik	SAP	EAN	EM	EUR/EM
Pritrdilni komplet FINAL	4	133108	3831054729015	kpl	8,90
Navojna palica M12/1000	8	900003570	4037494850558	kos	4,00
Zalivna masa ISOTAL 5kg	2	132350	3831054729039	kos	7,50
Lepilo KEMAKOL 5kg	2	132347	3831054729046	kos	10,30

Tehnične spremembe pridržane. Veljavnost cenika od 20. 3. 2024 do preklica.

FINAL ELEMENTI

za izvedbo dimiškega zaključka - črni

SCHIEDEL
FINAL

Enojni Ø 14 - Ø 20 cm



Svetli Ø UNI plus dimnika	14	16	18	20
---------------------------	----	----	----	----



FINAL element	14	16	18	20
13 kos/m				
SAP	118703	118703	118704	118704
EAN	4037494448557	4037494448557	4037494448564	4037494448564
EUR/kos	11,70	11,70	13,20	13,20
Zunanja mera	34/34	34/34	38/38	38/38
Teža kg/kos	9,70	9,70	11,00	11,00



Krovna plošča FINAL	14	16	18	20
Previs 2,5 cm				
SAP	118042	118042	118355	118355
EAN	4037494443507	4037494443507	4037494443514	4037494443514
EUR/kos	43,40	43,40	50,80	50,80

Enojni Ø 14 - Ø 20 cm



Svetli Ø UNI plus dimnika	14	16	18	20
---------------------------	----	----	----	----



FINAL UNI ISO plus SET - zaključni višine 1,33 m	14	16	18	20
Vsebina: elementi FINAL (17 kos), dimne cevi (2 kos), izolacijske plošče, lepilo za el. FINAL (2 x 5 kg), krovna plošča, zalivna masa ISOTAL (2 x 5 kg), komplet za statično stabilnost (navojne palice (8 x 1 m), pritrdilni set FINAL (4 kos)), ognjeobstojno lepilo rapid v kartuši (1 kos), pištola za kartuše, navodilo za montažo.				
SAP	-	137110	137111	137112
EAN	-	4051921575579	4051921575586	4051921575593
EUR/kpl	-	353,50	357,80	366,50

+



Paket omega zaključka UNI ISO plus	14	16	18	20
Vsebina: distančna rozeta, omega zaključek, tesnilni kit.				
SAP	135704	135705	135706	135707
EAN	4051921574848	4051921574855	4051921574862	4051921574879
EUR/kos	112,80	112,80	121,40	121,40

ali



Paket konusnega zaključka UNI ISO plus	14	16	18	20
Vsebina: konusni nastavek, dimna cev, tesnilna pasta, pokrov proti padavinam.				
SAP	135712	135713	135714	135715
EAN	4051921574923	4051921574930	4051921574947	4051921574954
EUR/kos	131,50	141,70	154,70	189,30

Dodatki (za lepljenje in zagotavljanje statične stabilnosti FINAL zaključka)

	Poraba/dimnik	SAP	EAN	EM	EUR/EM
Pritrdilni komplet FINAL	4	133108	3831054729015	kpl	8,90
Navojna palica M12/1000	8	900003570	4037494850558	kos	4,00
Zalivna masa ISOTAL 5kg	2	132350	3831054729039	kos	7,50
Lepilo KEMAKOL 5kg	2	132347	3831054729046	kos	10,30

Pomembno:

■ Preverite našo tehnično dokumentacijo (slike so simbolične).

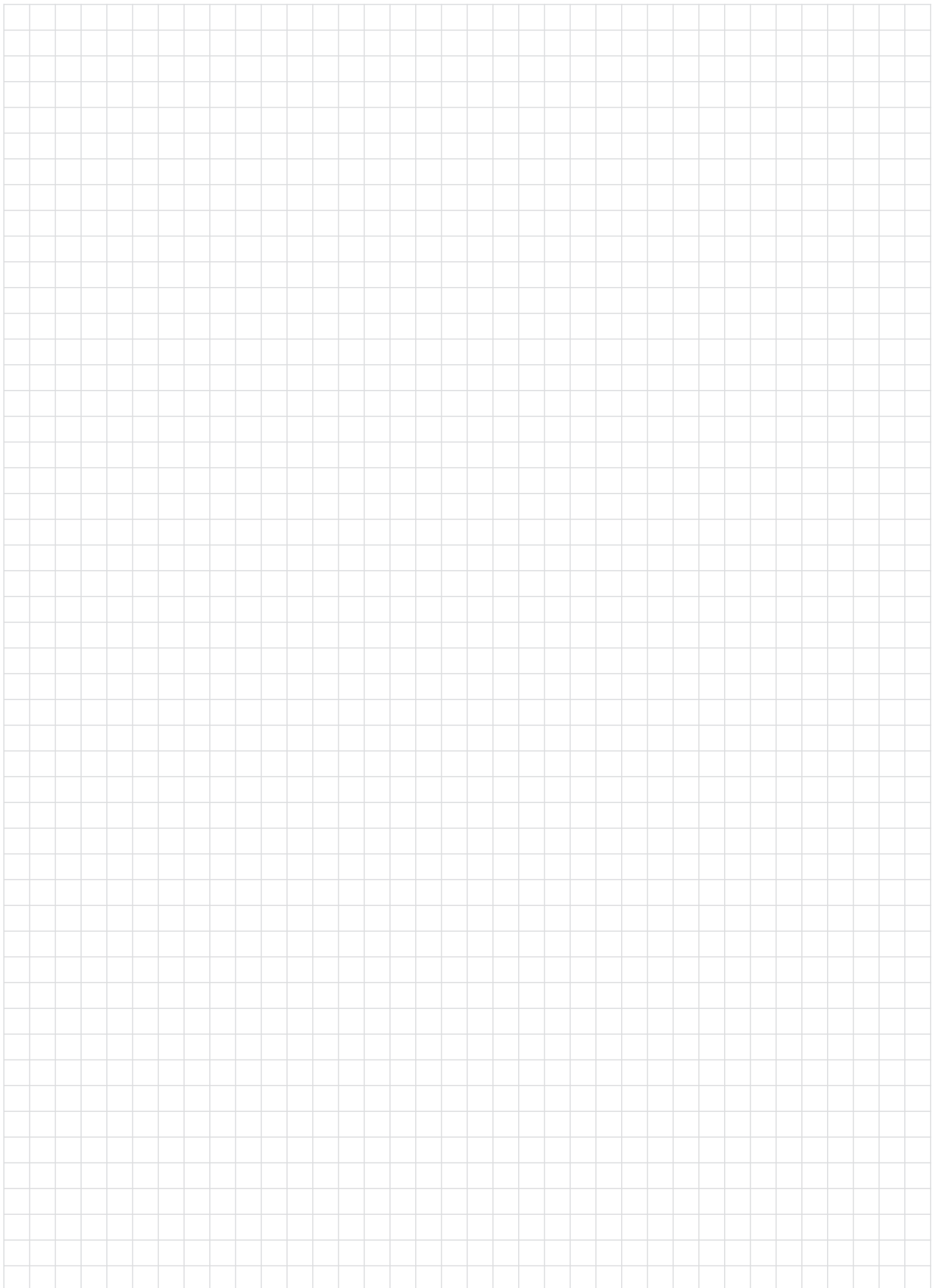



















Seznam materiala za UNI ISO plus dimnik: _____, H = _____ m

Objekt / stranka: _____

Datum: _____

SCHIEDEL

		Enota	€/EM	Skupaj
	Dimniški plašč EZ ZZ ZZK    EZL ZZL ZZLK   	kos		
	Betonski podstavek 	kos		
	Osnovni paket + Podstavek kondenzne posode 	kos		
	Izolacijske plošče MAT plus (1 paket = 1 m dimnika) 	pkt		
	Dimna cev (višina 66 cm) 	kos		
	Priključek za dimniška vratca (višina 33 cm) 	kos		
	Priključek za peč (90°/45°) (tudi za priključek regulatorja vleka) višina 33 cm (90°), 66,5 cm (45°) 	kos		
	Krovna plošča - za obzidavo (tip U) - brez obzidave (tip B) - final 	kos		
	Pritrdilni set za krovno ploščo 	kos		
	FINAL set 1,33 m 	kos		
	Paket konusnega zaključka ali Paket omega zaključka 	kos		
Malta za zidanje plaščev (vreča 25 kg) 	kos			
Žig in podpis trgovca Cene v skladu z veljavnim cenikom Schiedel Pogoji dobave in plačila medsebojno dogovorjeni!	Obložni element Op.: ne vsebuje konusnega nastavka! Obložni element naročite s posebnim naročniškim listom, ki ga najdete na spletu, ali v ceniku keramičnih dimnikov!	Material: _____ Prevoz: _____ DDV: _____	Skupni znesek z DDV: _____	

Pridržujemo si pravico do tehničnih sprememb!

Pomembno:

■ Preverite našo tehnično dokumentacijo (slike so simbolične).

→ Schiedel UNI PLUS

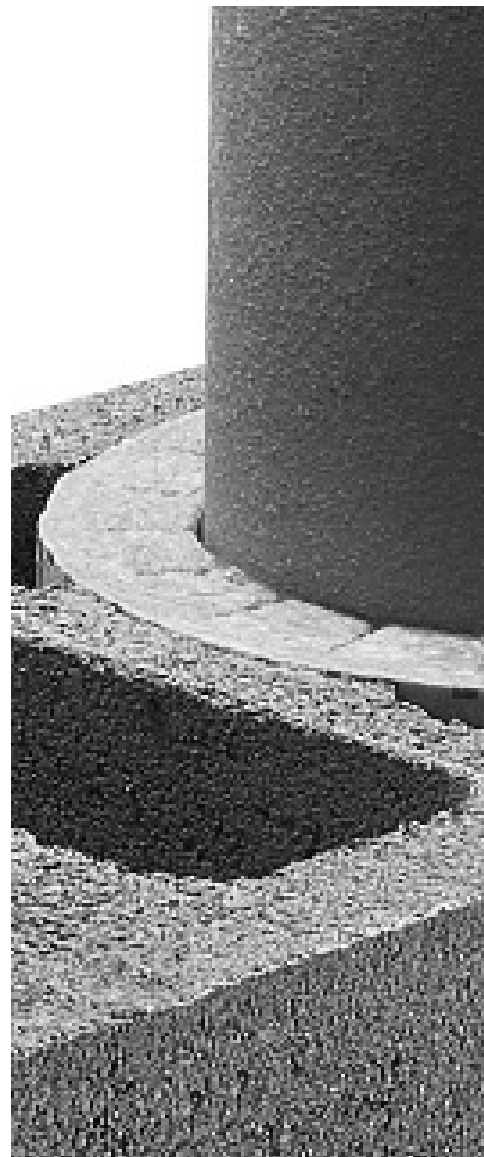

Klasičen dimniški sistem primeren za vse vrste goriv in kotlov.



SCHIEDEL

UNI PLUS



UNI***Plus

Enojni Ø 14 - Ø 20 cm

SCHIEDEL
UNI PLUS

→ Svetli premer dimnika	14	16	18	20
-------------------------	----	----	----	----



Dimnik UNI plus EZ	Tip	UNI plus 14	UNI plus 16	UNI plus 18	UNI plus 20
	Zunanja mera	32/32	32/32	36/36	36/36
	Teža kg/m	79	81	90	92



Dimniški plašč UNI plus		14-16	14-16	18-20	18-20
3 kos/m	SAP	100351	100351	100353	100353
	EAN	4037494089569	4037494089569	4037494089934	4037494089934
	EUR/kos	13,20	13,20	14,80	14,80



Dimna cev		14	16	18	20
3 kos/m	SAP	100373	100374	100375	100376
	EAN	4037494089897	4037494089903	4037494089910	4037494089927
	EUR/kos	11,70	14,80	17,60	17,60



Priključek za dimniška vratca		14	16	18	20
Višina 66 cm	SAP	100427	100428	100429	100430
	EAN	4037494090435	4037494090442	4037494090459	4037494090466
	EUR/kos	59,40	63,90	79,60	82,60



Priključek za peč pod kotom 90°		14/14	16/16	18/18	20/20
Višina 66 cm	SAP	100419	100420	100421	100422
	EAN	4037494090237	4037494090244	4037494090251	4037494090268
	EUR/kos	55,10	59,40	75,20	76,80



Izolacijske plošče MAT plus		14	16	18	20
1 paket/m	SAP	100539	100378	100540	100380
	EAN	4051921733030	4051921733009	4051921733047	4051921645814
	EUR/pkt	23,30	24,80	26,20	27,90

Pomembno:

■ Preverite našo tehnično dokumentacijo (slike so simbolične).

UNI***Plus

Enojni Ø 14 - Ø 20 cm

SCHIEDEL
UNI PLUS

→ Svetli premer dimnika	14	16	18	20
-------------------------	----	----	----	----



Osnovni paket UNI PLUS

Vsebina: kondenzna posoda z odvodom, adapter gumi za odvod kondenza, podstavek, dimniška vratca, ventilacijska rešetka, šablona za maltnje, izolacijske plošče za RA priključek, zaščitni karton in obroč za ometavanje, ognjeobstojno lepilo rapid v kartuši, pištola za kartuše, navodilo za montažo.

	14	16	18	20
SAP	132615	132616	132617	132618
EAN	3831054726199	3831054726205	3831054726212	3831054726229
EUR/kos	174,70	181,80	194,90	203,60



Podstavek UNI plus

	14-16	14-16	18-20	18-20
SAP	132540	132540	132541	132541
EAN	3831054725932	3831054725932	3831054725949	3831054725949
EUR/kos	19,10	19,10	22,00	22,00



Konzolna plošča UNI plus

	14	16	18	20
SAP	100481	100481	100483	100483
EAN	4037494091234	4037494091234	4037494091241	4037494091241
EUR/kos	53,60	53,60	57,80	57,80



Krovna plošča UNI plus U

Za obzidavo, previs 15 cm

	14	16	18	20
SAP	103873	103873	103874	103874
EAN	4037494091074	4037494091074	4037494091104	4037494091104
EUR/kos	72,50	72,50	76,80	76,80



Krovna plošča UNI plus B

Za fasadno oblogo, previs 8,5 cm

	14	16	18	20
SAP	102873	102873	102874	102874
EAN	4037494090954	4037494090954	4037494090961	4037494090961
EUR/kos	72,50	72,50	76,80	76,80



Pritrdilni set za krovno ploščo

SAP	102003
EAN	4037494055502
EUR/kos	22,00

UNI***Plus

Enojni Ø 14 - Ø 20 cm

SCHIEDEL
UNI PLUS

→ Svetli premer dimnika	14	16	18	20
-------------------------	----	----	----	----



Konusni nastavek UNI plus	14	16	18	20
SAP	103891	103892	103893	103894
EAN	4037494090916	4037494090923	4037494090930	4037494090947
EUR/kos	71,00	78,20	83,80	91,10



ABS Pokrov proti padavinam 1218	14	16	18	20
SAP	100234	100234	100234	100235
EAN	4049723004236	4049723004236	4049723004236	4049723004243
EUR/kos	52,20	52,20	52,20	72,50



Silikonski kit za konus UNI	14	16	18	20
SAP		102525		
EAN		4037494005750		
EUR/kos		13,20		



Dilatacijska rozeta UNI plus	14	16	18	20
V primeru zaključka brez konusnega nastavka, montira se na krovno ploščo.				
SAP	132605	132606	132607	132430
EAN	3831054726687	3831054726694	3831054726700	3831054726717
EUR/kos	32,20	32,20	39,10	39,10



Omega zaključek	Tip (enojni)	A Ø 14/16	B Ø 18/20
SAP		135361	135362
EAN		4051921574503	4051921574510
EUR/kos		66,50	68,10



Malta za zidanje plaščev 25 kg	14	16	18	20
SAP	132348	132348	132348	132348
EAN	3831054716657	3831054716657	3831054716657	3831054716657
EUR/kos	11,70	11,70	11,70	11,70
Poraba kg/m	5	5,5	6	6,5

Pomembno:

■ Preverite našo tehnično dokumentacijo (slike so simbolične).

UNI***Plus

Enojni z ventilacijo Ø 14 - Ø 20 cm

SCHIEDEL
UNI PLUS

→ Svetli premer dimnika	14L	16L	18L	20L
-------------------------	-----	-----	-----	-----

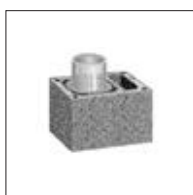

Dimnik UNI plus EZL	Tip	UNI plus 14L	UNI plus 16L	UNI plus 18L	UNI plus 20L
	Zunanja mera	32/46	32/46	36/50	36/50
	Teža kg/m	109	110	126	129



Dimniški plašč UNI plus		14-16	14-16	18-20	18-20
3 kos/m	SAP	100361	100361	100363	100363
	EAN	4037494089941	4037494089941	4037494089958	4037494089958
	EUR/kos	19,10	19,10	20,40	20,40



Dimna cev		14	16	18	20
3 kos/m	SAP	100373	100374	100375	100376
	EAN	4037494089897	4037494089903	4037494089910	4037494089927
	EUR/kos	11,70	14,80	17,60	17,60



Priključek za dimniška vratca		14	16	18	20
Višina 66 cm	SAP	100427	100428	100429	100430
	EAN	4037494090435	4037494090442	4037494090459	4037494090466
	EUR/kos	59,40	63,90	79,60	82,60



Priključek za peč pod kotom 90°		14/14	16/16	18/18	20/20
Višina 66 cm	SAP	100419	100420	100421	100422
	EAN	4037494090237	4037494090244	4037494090251	4037494090268
	EUR/kos	55,10	59,40	75,20	76,80



Izolacijske plošče MAT plus		14	16	18	20
1 paket/m	SAP	100539	100378	100540	100380
	EAN	4051921733030	4051921733009	4051921733047	4051921645814
	EUR/pkt	23,30	24,80	26,20	27,90

→ Svetli premer dimnika	14L	16L	18L	20L
-------------------------	-----	-----	-----	-----

**Osnovni paket UNI PLUS**

Vsebina: kondenzna posoda z odvodom, adapter gumi za odvod kondenza, podstavek, dimniška vratca, ventilacijska rešetka, šablona za maltanje, izolacijske plošče za RA priključek, zaščitni karton in obroč za ometavanje, ognjeobstojno lepilo rapid v kartuši, pištola za kartuše, navodilo za montažo.

	14	16	18	20
SAP	132615	132616	132617	132618
EAN	3831054726199	3831054726205	3831054726212	3831054726229
EUR/kos	174,70	181,80	194,90	203,60

**Podstavek UNI plus**

	14-16	14-16	18-20	18-20
SAP	132542	132542	132543	132543
EAN	3831054725956	3831054725956	3831054725963	3831054725963
EUR/kos	23,30	23,30	26,20	26,20

**Konzolna plošča UNI plus**

	14L	16L	18L	20L
SAP	100490	100490	100492	100492
EAN	4037494091258	4037494091258	4037494091265	4037494091265
EUR/kos	63,90	63,90	71,00	71,00

**Krovna plošča UNI plus U**

Za obzidavo, previs 15 cm

	14L	16L	18L	20L
SAP	103880	103880	103882	103882
EAN	4037494091111	4037494091111	4037494091128	4037494091128
EUR/kos	82,60	82,60	88,10	88,10

**Krovna plošča UNI plus B**

Za fasadno oblogo, previs 8,5 cm

	14L	16L	18L	20L
SAP	102402	102402	102404	102404
EAN	4037494802533	4037494802533	4037494802540	4037494802540
EUR/kos	82,60	82,60	88,10	88,10

**Pritrdilni set za krovno ploščo**

SAP	102003
EAN	4037494055502
EUR/kos	22,00

Pomembno:

- Preverite našo tehnično dokumentacijo (slike so simbolične).

→ Svetli premer dimnika	14L	16L	18L	20L
-------------------------	-----	-----	-----	-----



Silikonski kit za konus UNI

SAP	102525			
EAN	4037494005750			
EUR/kos	13,20			



Dilatacijska rozeta UNI plus

V primeru zaključka brez konusnega nastavka, montira se na krovno ploščo.

	14	16	18	20
SAP	132605	132606	132607	132430
EAN	3831054726687	3831054726694	3831054726700	3831054726717
EUR/kos	32,20	32,20	39,10	39,10



Omega zaključek

	Tip (enojni)	C Ø 14/16 L	D Ø 18/20 L
SAP		135363	135364
EAN		4051921574527	4051921574534
EUR/kos		71,00	72,50



Malta za zidanje plaščev 25 kg

SAP	132348	132348	132348	132348
EAN	3831054716657	3831054716657	3831054716657	3831054716657
EUR/kos	11,70	11,70	11,70	11,70
Poraba kg/m	5	5,5	6	6,5

UNI***Plus

Dvojni Ø 14 - Ø 20 cm

SCHIEDEL
UNI PLUS

→ Svetli premer dimnika	14/14	16/16	18/18	20/20
-------------------------	-------	-------	-------	-------



Dimnik UNI plus ZZ	Tip	UNI plus 1414	UNI plus 1616	UNI plus 1818	UNI plus 2020
	Zunanja mera	32/59	32/59	36/67	36/67
	Teža kg/m	138	142	163	168



Dimniški plašč UNI plus		14-16	14-16	18-20	18-20
3 kos/m	SAP	100352	100352	100355	100355
	EAN	4037494089965	4037494089965	4037494089972	4037494089972
	EUR/kos	22,00	22,00	26,20	26,20



Dimna cev		14	16	18	20
3 kos/m	SAP	100373	100374	100375	100376
	EAN	4037494089897	4037494089903	4037494089910	4037494089927
	EUR/kos	11,70	14,80	17,60	17,60



Priključek za dimniška vratca		14	16	18	20
Višina 66 cm	SAP	100427	100428	100429	100430
	EAN	4037494090435	4037494090442	4037494090459	4037494090466
	EUR/kos	59,40	63,90	79,60	82,60

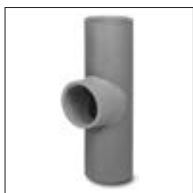

Priključek za peč pod kotom 90°		14/14	16/16	18/18	20/20
Višina 66 cm	SAP	100419	100420	100421	100422
	EAN	4037494090237	4037494090244	4037494090251	4037494090268
	EUR/kos	55,10	59,40	75,20	76,80



Izolacijske plošče MAT plus		14	16	18	20
1 paket/m	SAP	100539	100378	100540	100380
	EAN	4051921733030	4051921733009	4051921733047	4051921645814
	EUR/pkt	23,30	24,80	26,20	27,90

Pomembno:

■ Preverite našo tehnično dokumentacijo (slike so simbolične).

UNI***Plus

Dvojni Ø 14 - Ø 20 cm

SCHIEDEL
UNI PLUS

→ Svetli premer dimnika	14/14	16/16	18/18	20/20
-------------------------	-------	-------	-------	-------



Osnovni paket UNI PLUS

Vsebina: kondenzna posoda z odvodom, adapter gumi za odvod kondenza, podstavek, dimniška vratca, ventilacijska rešetka, šablona za maltanje, izolacijske plošče za RA priključek, zaščitni karton in obroč za ometavanje, ognjeobstojno lepilo rapid v kartuši, pištola za kartuše, navodilo za montažo.

	14	16	18	20
SAP	132615	132616	132617	132618
EAN	3831054726199	3831054726205	3831054726212	3831054726229
EUR/kos	174,70	181,80	194,90	203,60



Podstavek UNI plus

	14-16	14-16	18-20	18-20
SAP	132544	132544	132545	132545
EAN	3831054725970	3831054725970	3831054725987	3831054725987
EUR/kos	33,40	33,40	37,70	37,70



Konzolna plošča UNI plus

	14/14	16/16	18/18	20/20
SAP	100482	100482	100485	100485
EAN	4037494091272	4037494091272	4037494091289	4037494091289
EUR/kos	95,40	95,40	105,50	105,50



Krovna plošča UNI plus U

Za obzidavo, previs 15 cm

	14/14	16/16	18/18	20/20
SAP	102896	102896	103876	103876
EAN	4037494091135	4037494091135	4037494091142	4037494091142
EUR/kos	92,60	92,60	102,60	102,60



Krovna plošča UNI plus B

Za fasadno oblogo, previs 8,5 cm

	14/14	16/16	18/18	20/20
SAP	102399	102399	102401	102401
EAN	4037494802502	4037494802502	4037494802519	4037494802519
EUR/kos	92,60	92,60	102,60	102,60



Pritrdilni set za krovno ploščo

SAP	102003
EAN	4037494055502
EUR/kos	22,00

UNI***Plus

Dvojni Ø 14 - Ø 20 cm

SCHIEDEL
UNI PLUS

Svetli premer dimnika	14/14	16/16	18/18	20/20
-----------------------	-------	-------	-------	-------



Dilatacijska rozeta UNI plus

V primeru zaključka brez konusnega nastavka, montira se na krovno ploščo.

	14	16	18	20
SAP	132605	132606	132607	132430
EAN	3831054726687	3831054726694	3831054726700	3831054726717
EUR/kos	32,20	32,20	39,10	39,10



Omega zaključek

Tip (dvojni)	E Ø 14-14	F Ø 18-18
SAP	135365	135366
EAN	4051921574541	4051921574558
EUR/kos	80,80	82,60



Malta za zidanje plaščev 25 kg

	14	16	18	20
SAP	132348	132348	132348	132348
EAN	3831054716657	3831054716657	3831054716657	3831054716657
EUR/kos	11,70	11,70	11,70	11,70
Poraba kg/m	5	5,5	6	6,5

Pomembno:

■ Preverite našo tehnično dokumentacijo (slike so simbolične).

UNI***Plus

Dvojni z ventilacijo Ø 14 - Ø 20 cm

SCHIEDEL
UNI PLUS

→ Svetli premer dimnika 14/L/14 16/L/16 18/L/18 20/L/20



Dimnik UNI plus ZZL	Tip	UNI plus 14L14	UNI plus 16L16	UNI plus 18L18	UNI plus 20L20
	Zunanja mera	32/72	32/72	36/83	36/83
	Teža kg/m	165	167	192	198



Dimniški plašč UNI plus		14-16	14-16	18-20	18-20
3 kos/m	SAP	100362	100362	100365	100365
	EAN	4037494089989	4037494089989	4037494089996	4037494089996
	EUR/kos	26,20	26,20	32,20	32,20



Dimna cev		14	16	18	20
3 kos/m	SAP	100373	100374	100375	100376
	EAN	4037494089897	4037494089903	4037494089910	4037494089927
	EUR/kos	11,70	14,80	17,60	17,60



Priključek za dimniška vratca		14	16	18	20
Višina 66 cm	SAP	100427	100428	100429	100430
	EAN	4037494090435	4037494090442	4037494090459	4037494090466
	EUR/kos	59,40	63,90	79,60	82,60



Priključek za peč pod kotom 90°		14/14	16/16	18/18	20/20
Višina 66 cm	SAP	100419	100420	100421	100422
	EAN	4037494090237	4037494090244	4037494090251	4037494090268
	EUR/kos	55,10	59,40	75,20	76,80



Izolacijske plošče MAT plus		14	16	18	20
1 paket/m	SAP	100539	100378	100540	100380
	EAN	4051921733030	4051921733009	4051921733047	4051921645814
	EUR/pkt	23,30	24,80	26,20	27,90

Tehnične spremembe pridržane. Veljavnost cenika od 20. 3. 2024 do preklica.

→ Svetli premer dimnika	14/L/14	16/L/16	18/L/18	20/L/20
-------------------------	---------	---------	---------	---------

**Osnovni paket UNI PLUS**

Vsebina: kondenzna posoda z odvodom, adapter gumi za odvod kondenza, podstavek, dimniška vratca, ventilacijska rešetka, šablona za maltanje, izolacijske plošče za RA priključek, zaščitni karton in obroč za ometavanje, ognjeobstojno lepilo rapid v kartuši, pištola za kartuše, navodilo za montažo.

	14	16	18	20
SAP	132615	132616	132617	132618
EAN	3831054726199	3831054726205	3831054726212	3831054726229
EUR/kos	174,70	181,80	194,90	203,60

**Podstavek UNI plus**

	14-16	14-16	18-20	18-20
SAP	132546	132546	132548	132548
EAN	3831054725994	3831054725994	3831054726007	3831054726007
EUR/kos	37,70	37,70	46,50	46,50

**Konzolna plošča UNI plus**

	14/L/14	16/L/16	18/L/18	20/L/20
SAP	100491	100491	100494	100494
EAN	4037494091296	4037494091296	4037494091302	4037494091302
EUR/kos	109,70	109,70	115,60	115,60

**Krovna plošča UNI plus U**

Za obzidavo, previs 15 cm

	14/L/14	16/L/16	18/L/18	20/L/20
SAP	103881	103881	103884	103884
EAN	4037494091159	4037494091159	4037494091166	4037494091166
EUR/kos	93,90	93,90	101,20	101,20

**Krovna plošča UNI plus B**

Za fasadno oblogo, previs 8,5 cm

	14/L/14	16/L/16	18/L/18	20/L/20
SAP	132473	132473	102406	102406
EAN	3831054749402	3831054749402	4037494802595	4037494802595
EUR/kos	93,90	93,90	93,90	93,90

**Pritrdilni set za krovno ploščo**

SAP	102003
EAN	4037494055502
EUR/kos	22,00

Pomembno:

- Preverite našo tehnično dokumentacijo (slike so simbolične).

UNI***Plus

Dvojni z ventilacijo Ø 14 - Ø 20 cm

SCHIEDEL
UNI PLUS

→ Svetli premer dimnika	14/L/14	16/L/16	18/L/18	20/L/20
-------------------------	---------	---------	---------	---------

Dilatacijska rozeta UNI plus

V primeru zaključka brez konusnega nastavka, montira se na krovno ploščo.

	14	16	18	20
SAP	132605	132606	132607	132430
EAN	3831054726687	3831054726694	3831054726700	3831054726717
EUR/kos	32,20	32,20	39,10	39,10

Omega zaključek

Tip (dvojni)	G Ø 1414 L	H Ø 1818L
SAP	135367	135368
EAN	4051921574565	4051921574572
EUR/kos	88,10	91,10

Malta za zidanje plaščev 25 kg

SAP	132348	132348	132348	132348
EAN	3831054716657	3831054716657	3831054716657	3831054716657
EUR/kos	11,70	11,70	11,70	11,70
Poraba kg/m	5	5,5	6	6,5

UNI***Plus

Dvojni kombinirani Ø 14 - Ø 20 cm

SCHIEDEL
UNI PLUS

→ Svetli premer dimnika	18/14	18/16	20/14	20/16
-------------------------	-------	-------	-------	-------



Dimnik UNI plus ZZK	Tip	UNI plus 1814	UNI plus 1816	UNI plus 2014	UNI plus 2016
	Zunanja mera	36/64	36/64	36/64	36/64
	Teža kg/m	165	166	168	169



Dimniški plašč UNI plus		14-20	14-20	14-20	14-20
3 kos/m	SAP	100354	100354	100354	100354
	EAN	4037494090008	4037494090008	4037494090008	4037494090008
	EUR/kos	26,20	26,20	26,20	26,20



Dimna cev		18	18	20	20
3 kos/m	SAP	100375	100375	100376	100376
	EAN	4037494089910	4037494089910	4037494089927	4037494089927
	EUR/kos	17,60	17,60	17,60	17,60
		14	16	14	16
	SAP	100373	100374	100373	100374
	EAN	4037494089897	4037494089903	4037494089897	4037494089903
	EUR/kos	11,70	14,80	11,70	14,80



Priključek za dimniška vratca		18	18	20	20
Višina 66 cm	SAP	100429	100429	100430	100430
	EAN	4037494090459	4037494090459	4037494090466	4037494090466
	EUR/kos	79,60	79,60	82,60	82,60
		14	16	14	16
	SAP	100427	100428	100427	100428
	EAN	4037494090435	4037494090442	4037494090435	4037494090442
	EUR/kos	59,40	63,90	59,40	63,90



Priključek za peč pod kotom 90°		18/18	18/18	20/20	20/20
Višina 66 cm	SAP	100421	100421	100422	100422
	EAN	4037494090251	4037494090251	4037494090268	4037494090268
	EUR/kos	75,20	75,20	76,80	76,80
		14/14	16/16	14/14	16/16
	SAP	100419	100420	100419	100420
	EAN	4037494090237	4037494090244	4037494090237	4037494090244
	EUR/kos	55,10	59,40	55,10	59,40



Izolacijske plošče MAT plus		18	18	20	20
1 paket/m	SAP	100540	100540	100380	100380
	EAN	4051921733047	4051921733047	4051921645814	4051921645814
	EUR/pkt	26,20	26,20	27,90	27,90
		14	16	14	16
1 paket/m	SAP	100539	100378	100539	100378
	EAN	4051921733030	4051921733009	4051921733030	4051921733009
	EUR/pkt	23,30	24,80	23,30	24,80

Pomembno:

■ Preverite našo tehnično dokumentacijo (slike so simbolične).

UNI***Plus

Dvojni kombinirani Ø 14 - Ø 20 cm

SCHIEDEL
UNI PLUS

→ Svetli premer dimnika	18/14	18/16	20/14	20/16
-------------------------	-------	-------	-------	-------



Osnovni paket UNI PLUS

Vsebina: kondenzna posoda z odvodom, adapter gumi za odvod kondenza, podstavek, dimniška vratca, ventilacijska rešetka, šablona za maltanje, izolacijske plošče za RA priključek, zaščitni karton in obroč za ometavanje, ognjeobstojno lepilo rapid v kartuši, pištola za kartuše, navodilo za montažo.

	18	18	20	20
SAP	132617	132617	132618	132618
EAN	3831054726212	3831054726212	3831054726229	3831054726229
EUR/kos	194,90	194,90	203,60	203,60
	14	16	14	16
SAP	132615	132616	132615	132616
EAN	3831054726199	3831054726205	3831054726199	3831054726205
EUR/kos	174,70	181,80	174,70	181,80



Podstavek UNI plus

	14-20	14-20	14-20	14-20
SAP	132549	132549	132549	132549
EAN	3831054726014	3831054726014	3831054726014	3831054726014
EUR/kos	39,10	39,10	39,10	39,10



Konzolna plošča UNI plus

	18/14	18/16	20/14	20/16
SAP	100484	100484	100484	100484
EAN	4037494091319	4037494091319	4037494091319	4037494091319
EUR/kos	109,70	109,70	109,70	109,70



Krovna plošča UNI plus U

Za obzidavo, previs 15 cm

	18/14	18/16	20/14	20/16
SAP	103875	103875	103875	103875
EAN	4037494091173	4037494091173	4037494091173	4037494091173
EUR/kos	122,90	122,90	122,90	122,90



Krovna plošča UNI plus B

Za fasadno oblogo, previs 8,5 cm

	18/14	18/16	20/14	20/16
SAP	102400	102400	102400	102400
EAN	4037494802526	4037494802526	4037494802526	4037494802526
EUR/kos	122,90	122,90	122,90	122,90



Pritrdilni set za krovno ploščo

SAP	102003
EAN	4037494055502
EUR/kos	22,00

→ Svetli premer dimnika	18/14	18/16	20/14	20/16
-------------------------	-------	-------	-------	-------



Dilatacijska rozeta UNI plus

V primeru zaključka brez konusnega nastavka, montira se na krovno ploščo.

	14	16	18	20
SAP	132605	132606	132607	132430
EAN	3831054726687	3831054726694	3831054726700	3831054726717
EUR/kos	32,20	32,20	39,10	39,10



Omega zaključek

Tip (dvojni)	I Ø 1418
SAP	135369
EAN	4051921574589
EUR/kos	96,90



Malta za zidanje plaščev 25 kg

SAP	132348	132348	132348	132348
EAN	3831054716657	3831054716657	3831054716657	3831054716657
EUR/kos	11,70	11,70	11,70	11,70
Poraba kg/m	5	5,5	6	6,5

Pomembno:

■ Preverite našo tehnično dokumentacijo (slike so simbolične).

UNI***Plus

Dvojni kombinirani z ventilacijo

Ø 14 - Ø 20 cm

SCHIEDEL

UNI PLUS

→ Svetli premer dimnika	18/L/14	18/L/16	20/L/14	20/L/16
-------------------------	---------	---------	---------	---------



Dimnik UNI plus ZZLK	Tip	UNI plus 18L14	UNI plus 18L16	UNI plus 20L14	UNI plus 20L16
	Zunanja mera	36/81	36/81	36/81	36/81
	Teža kg/m	194	195	198	199



Dimniški plašč UNI plus	Tip	12-20	12-20	12-20	12-20
3 kos/m	SAP	100364	100364	100364	100364
	EAN	4037494090015	4037494090015	4037494090015	4037494090015
	EUR/kos	32,20	32,20	32,20	32,20



Dimna cev		18	18	20	20
3 kos/m	SAP	100375	100375	100376	100376
	EAN	4037494089910	4037494089910	4037494089927	4037494089927
	EUR/kos	17,60	17,60	17,60	17,60
		14	16	14	16
	SAP	100373	100374	100373	100374
	EAN	4037494089897	4037494089903	4037494089897	4037494089903
	EUR/kos	11,70	14,80	11,70	14,80



Priključek za dimniška vratca		18	18	20	20
Višina 66 cm	SAP	100429	100429	100430	100430
	EAN	4037494090459	4037494090459	4037494090466	4037494090466
	EUR/kos	79,60	79,60	82,60	82,60
		14	16	14	16
	SAP	100427	100428	100427	100428
	EAN	4037494090435	4037494090442	4037494090435	4037494090442
	EUR/kos	59,40	63,90	59,40	63,90



Priključek za peč pod kotom 90°		18/18	18/18	20/20	20/20
Višina 66 cm	SAP	100421	100421	100422	100422
	EAN	4037494090251	4037494090251	4037494090268	4037494090268
	EUR/kos	75,20	75,20	76,80	76,80
		14/14	16/16	14/14	16/16
	SAP	100419	100420	100419	100420
	EAN	4037494090237	4037494090244	4037494090237	4037494090244
	EUR/kos	55,10	59,40	55,10	59,40



Izolacijske plošče MAT plus		18	18	20	20
1 paket/m	SAP	100540	100540	100380	100380
	EAN	4051921733047	4051921733047	4051921645814	4051921645814
	EUR/pkt	26,20	26,20	27,90	27,90
1 paket/m		14	16	14	16
	SAP	100539	100378	100539	100378
	EAN	4051921733030	4051921733009	4051921733030	4051921733009
	EUR/pkt	23,30	24,80	23,30	24,80

Tehnične spremembe pridržane. Veljavnost cenika od 20. 3. 2024 do preklica.

UNI***Plus

Dvojni kombinirani z ventilacijo

Ø 14 - Ø 20 cm

SCHIEDEL
UNI PLUS

→ Svetli premer dimnika	18/L/14	18/L/16	20/L/14	20/L/16
-------------------------	---------	---------	---------	---------



Osnovni paket UNI PLUS

Vsebina: kondenzna posoda z odvodom, adapter gumi za odvod kondenza, podstavek, dimniška vratca, ventilacijska rešetka, šablona za maltanje, izolacijske plošče za RA priključek, zaščitni karton in obroč za ometavanje, ognjeobstojno lepilo rapid v kartuši, pištola za kartuše, navodilo za montažo.

	18	18	20	20
SAP	132617	132617	132618	132618
EAN	3831054726212	3831054726212	3831054726229	3831054726229
EUR/kos	194,90	194,90	203,60	203,60
	14	16	14	16
SAP	132615	132616	132615	132616
EAN	3831054726199	3831054726205	3831054726199	3831054726205
EUR/kos	174,70	181,80	174,70	181,80



Podstavek UNI plus

	14-20	14-20	14-20	14-20
SAP	132550	132550	132550	132550
EAN	3831054726021	3831054726021	3831054726021	3831054726021
EUR/kos	43,40	43,40	43,40	43,40



Konzolna plošča UNI plus

	18/L/14	18/L/16	20/L/14	20/L/16
SAP	100493	100493	100493	100493
EAN	4037494091326	4037494091326	4037494091326	4037494091326
EUR/kos	115,60	115,60	115,60	115,60



Krovna plošča UNI plus U

Za obzidavo, previs 15 cm

	18/L/14	18/L/16	20/L/14	20/L/16
SAP	103883	103883	103883	103883
EAN	4037494091180	4037494091180	4037494091180	4037494091180
EUR/kos	131,50	131,50	131,50	131,50



Krovna plošča UNI plus B

Za fasadno oblogo, previs 8,5 cm

	18/L/14	18/L/16	20/L/14	20/L/16
SAP	102405	102405	102405	102405
EAN	4037494802601	4037494802601	4037494802601	4037494802601
EUR/kos	131,50	131,50	131,50	131,50



Pritrdilni set za krovno ploščo

SAP	102003
EAN	4037494055502
EUR/kos	22,00

Pomembno:

- Preverite našo tehnično dokumentacijo (slike so simbolične).

UNI***Plus

Dvojni kombinirani z ventilacijo

Ø 14 - Ø 20 cm

SCHIEDEL

UNI PLUS

→ Svetli premer dimnika	18/L/14	18/L/16	20/L/14	20/L/16
-------------------------	---------	---------	---------	---------



Dilatacijska rozeta UNI plus

V primeru zaključka brez konusnega nastavka, montira se na krovno ploščo.

	14	16	18	20
SAP	132605	132606	132607	132430
EAN	3831054726687	3831054726694	3831054726700	3831054726717
EUR/kos	32,20	32,20	39,10	39,10



Omega zaključek

Tip (dvojni)	J Ø 1418 L
SAP	135370
EAN	4051921574596
EUR/kos	100,10



Malta za zidanje plaščev 25 kg

SAP	132348	132348	132348	132348
EAN	3831054716657	3831054716657	3831054716657	3831054716657
EUR/kos	11,70	11,70	11,70	11,70
Poraba kg/m	5	5,5	6	6,5

UNI***Plus Seti

SCHIEDEL

UNI PLUS

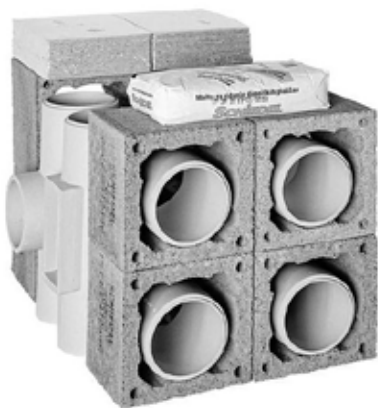

Vsebina: dimniški plašči, dimne cevi, priključek za vratca, priključek za peč, izolacijske plošče, betonski podstavek, kondenzna posoda z odvodom, izolacijski vložek za RA priključek, nosilci izolacije, šablona za maltanje, ventilacijska rešetka, vratca, malta za zidanje plaščev ognjeobstojno lepilo rapid v kartuši, pištola za kartuše, navodilo za montažo.

Svetli Ø UNI plus dimnika	14	16	18	20
---------------------------	----	----	----	----

Enojni Ø 14 - Ø 20 cm UNI***plus SET- začetni 3,00 m	14	16	18	20
SAP	131744	131745	131746	132625
EAN	3831054728445	3831054728452	3831054728469	3831054728476
EUR/pkt	523,70	548,30	605,80	640,50

Vsebina: dimniški plašči, dimne cevi, priključek za vratca, priključek za peč, izolacijske plošče, betonski podstavek, kondenzna posoda z odvodom, izolacijski vložek za RA priključek, nosilci izolacije, šablona za maltanje, ventilacijska rešetka, vratca, malta za zidanje plaščev ognjeobstojno lepilo rapid v kartuši, pištola za kartuše, navodilo za montažo.

Svetli Ø UNI plus dimnika	14L	16L	18L	20L
---------------------------	-----	-----	-----	-----

Enojni z ventilacijo Ø 14 - Ø 20 cm UNI***plus SET- začetni 3,00 m	14L	16L	18L	20L
SAP	-	132628	132629	132630
EAN	-	3831054728506	3831054728513	3831054728520
EUR/pkt	-	569,70	634,60	662,20

Vsebina: dimniški plašči, dimne cevi, priključek za vratca, priključek za peč, izolacijske plošče, betonski podstavek, kondenzna posoda z odvodom, izolacijski vložek za RA priključek, nosilci izolacije, šablona za maltanje, ventilacijska rešetka, vratca, malta za zidanje plaščev ognjeobstojno lepilo rapid v kartuši, pištola za kartuše, navodilo za montažo.

Enojni Ø 20 cm UNI***plus SET- začetni Ø 20 cm 3,00 m (RA 45°)	20
SAP	133687
EAN	38310544748221
EUR/pkt	640,50

Vsebina: dimniški plašči, dimne cevi, priključek za vratca, priključek za peč, izolacijske plošče, betonski podstavek, kondenzna posoda z odvodom, izolacijski vložek za priključek za peč RA 45°, nosilci izolacije, šablona za maltanje, ventilacijska rešetka, vratca, malta za zidanje plaščev ognjeobstojno lepilo rapid v kartuši, pištola za kartuše, navodilo za montažo.

Svetli Ø UNI plus dimnika	14	16	18	20
---------------------------	----	----	----	----

Enojni Ø 16 - Ø 20 cm UNI***plus SET- dimnik 7,00 m	14	16	18	20
SAP	-	164479	164480	164481
EAN	-	4051921821584	4051921821591	4051921821607
EUR/pkt	-	1090,00	1232,90	1256,30

Vsebina: dimniški plašč UNI plus, keramična cev, priključek za vratca, priključek za peč, izolacija UNI plus, osnovni paket UNI plus, krovna plošča Final, distančna rozeta UNI plus, omega zaključek.

Enojni Ø 18 - Ø 20 cm UNI***plus SET- dimnik 7,00 m (RA 45°)	14	16	18	20
SAP	-	-	164482	164483
EAN	-	-	4051921821614	4051921821621
EUR/pkt	-	-	1239,90	1271,70

Vsebina: dimniški plašč UNI plus, keramična cev, priključek za vratca, priključek za peč, izolacija UNI plus, osnovni paket UNI plus, krovna plošča Final, distančna rozeta UNI plus, omega zaključek.

Pomembno:

- Preverite našo tehnično dokumentacijo (slike so simbolične).

Enojni Ø 14 - Ø 20 cm

Svetli Ø UNI plus dimnika	14	16	18	20
---------------------------	----	----	----	----



FINAL UNI plus SET - zaključni višine 1,33 m - RDEČI	14	16	18	20
SAP	156485	156486	156487	156488
EAN	4051921733917	4051921733924	4051921733931	4051921733948
EUR/kpl	342,00	353,50	357,80	366,50

Vsebina: elementi FINAL (17 kos), dimne cevi (4 kos), izolacijske plošče, lepilo za el. FINAL (2 x 5 kg), krovna plošča, zalivna masa ISOTAL (2 x 5 kg), komplet za statično stabilnost (navojne palice (8 x 1 m), pritrdilni set FINAL (4 kos)), ognjeobstojno lepilo rapid v kartuši (1 kos), pištola za kartuše, navodilo za montažo.



FINAL UNI plus SET - zaključni višine 1,33 m - RJAVI	14	16	18	20
SAP	156489	156490	156491	156492
EAN	4051921733955	4051921733962	4051921733979	4051921733986
EUR/kpl	342,00	353,50	357,80	366,50

Vsebina: elementi FINAL (17 kos), dimne cevi (4 kos), izolacijske plošče, lepilo za el. FINAL (2 x 5 kg), krovna plošča, zalivna masa ISOTAL (2 x 5 kg), komplet za statično stabilnost (navojne palice (8 x 1 m), pritrdilni set FINAL (4 kos)), ognjeobstojno lepilo rapid v kartuši (1 kos), pištola za kartuše, navodilo za montažo.



FINAL UNI plus SET - zaključni višine 1,33 m - ČRNI	14	16	18	20
SAP	156493	156494	156495	156496
EAN	4051921733993	4051921734006	4051921734013	4051921734020
EUR/kpl	342,00	353,50	357,80	366,50

Vsebina: elementi FINAL (17 kos), dimne cevi (4 kos), izolacijske plošče, lepilo za el. FINAL (2 x 5 kg), krovna plošča, zalivna masa ISOTAL (2 x 5 kg), komplet za statično stabilnost (navojne palice (8 x 1 m), pritrdilni set FINAL (4 kos)), ognjeobstojno lepilo rapid v kartuši (1 kos), pištola za kartuše, navodilo za montažo.

+



Dilatacijska rozeta UNI plus	14	16	18	20
SAP	132605	132606	132607	132430
EAN	3831054726687	3831054726694	3831054726700	3831054726717
EUR/kos	32,20	32,20	39,10	39,10

V primeru zaključka brez konusnega nastavka, montira se na krovno ploščo.

+



Omega zaključek	Tip (enojni)	A Ø 14/16	B Ø 18/20
SAP		135361	135362
EAN		4051921574503	4051921574510
EUR/kos		66,50	68,10

ali



Konusni nastavek UNI plus	14	16	18	20
SAP	103891	103892	103893	103894
EAN	4037494090916	4037494090923	4037494090930	4037494090947
EUR/kos	71,00	78,20	83,80	91,10

UNI***Plus FINAL UNI plus SET za izvedbo dimniškega zaključka

SCHIEDEL

UNI PLUS

ali



Svetli premer dimnika	14	16	18	20
-----------------------	----	----	----	----



ABS Pokrov proti padavinam 1218	14	16	18	20
---------------------------------	----	----	----	----

SAP	100234	100234	100234	100235
EAN	4049723004236	4049723004236	4049723004236	4049723004243
EUR/kos	52,20	52,20	52,20	72,50

ali



Silikonski kit za konus UNI	14	16	18	20
-----------------------------	----	----	----	----

SAP		102525		
EAN		4037494005750		
EUR/kos		13,20		

Pomembno:

■ Preverite našo tehnično dokumentacijo (slike so simbolične).

→ Svetli premer dimnika	14	16	18	20
-------------------------	----	----	----	----



Kondenzna posoda z odvodom	14	16	18	20
SAP	102683	102684	102685	102686
EAN	4037494054581	4037494054598	4037393054604	4037494054611
EUR/kos	47,60	53,60	55,10	62,10



Priključek za peč pod kotom 45° Višina 66 cm	14/14	16/16	18/18	20/20
SAP	113815	113988	114045	114164
EAN	4037494440711	4037494440728	4037494440735	4037494440742
EUR/kos	79,60	76,80	82,60	93,90



Nos za priključek 90°	14	16	18	20
SAP	102726	102727	102728	102729
EAN koda	4037494136324	4037494136331	4037494136348	4037494136355
EUR/kos	47,70	49,30	49,30	49,30



Nos za priključek 45°	14	16	18	20
SAP	100433	100434	100435	100436
EAN koda	4037494136362	4037494136379	4037494136386	4037494136393
EUR/kos	47,70	49,30	49,30	49,30

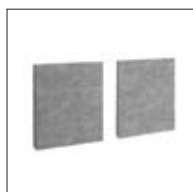

Vložek - izolacija 2 kosa za 1 RA priključek	14-16	14-16	18-20	18-20
SAP	132443	132443	132445	132445
EAN	3831054703077	3831054703077	3831054703091	3831054703091
EUR/kos	4,60	4,60	4,60	4,60



Nosilec izolacije 4 kosi za 1 RA priključek	14-16	14-16	18-20	18-20
SAP		132289		
EAN		3831054702995		
EUR/kos		1,60		

→ Svetli premer dimnika	14	16	18	20
-------------------------	----	----	----	----



Zaščitni set za priključek za peč

Vsebina: izolacijski plošči, nosilci izolacije, zaščitni obroč za ometavanje, zaščitni karton in žeblički za pritrdjevanje.

	14	16	18	20
SAP	132637	132638	132639	132640
EAN	3831054750156	3831054750163	3831054750170	3831054750187
EUR/kpl	24,80	24,80	24,80	33,80



Regulator vleka z eksplozijsko loputo

	16	+	16	18	20
SAP	101697		101724	108188	108189
EAN	4037494266458		4037494267011	4037494807231	4037494807248
EUR/kos	133,10		47,40	281,40	281,40



Šamotni okvir za vratca 1218

	14	16	18	20
SAP	102733	102734	102735	102736
EAN	4037494207451	4037494207475	4037494207499	4037494207512
EUR/kos	36,40	36,40	36,40	36,40



Vratca Schiedel bela

	Vratca Schiedel bela	Ključ za vratca
SAP	102785	900000181
EAN	4049723011234	4037494003992
EUR/kos	72,50	1,60



Ventilacijska vratca

	REVT 1023	REVT 1023 bela
SAP	100341	134110
EAN	4037494135396	4051921541376
EUR/kos	37,70	37,70



TEKASIL 300°C

Ognjeobstojni trajno elastični kit 300°C.

SAP	132431
EAN	3831054731803
EUR/kos	14,80

Pomembno:

- Preverite našo tehnično dokumentacijo (slike so simbolične).

→ Svetli premer dimnika	14	16	18	20
-------------------------	----	----	----	----



Tesnilni kit Rapid	14	16	18	20
SAP	100020	100020	100020	100020
EAN	4037494086124	4037494086124	4037494086124	4037494086124
EUR/kos	8,90	8,90	8,90	8,90
Poraba kos/m	0,40	0,40	0,50	0,50



Ognjeobstojno lepilo 1 kg				
Za naknadno montažo priključka na peč/vratca.				
SAP	102822			
EAN	4037494440506			
EUR/kos	7,50			



Ojačitveni set in zalivna malta	SET 4 x 4m M12	SET 4 x 6m M12
SAP	133661	133663
EAN	4037494034491	4037494034484
EUR/kos	104,00	146,40



Dilatacijska rozeta UNI	14	16	18	20
SAP	132416	132417	132418	132419
EAN	3831054703039	3831054703008	3831054703022	3831054703015
EUR/kos	32,20	32,20	39,10	39,10



Dimna rozeta RA s pokrovom	14	16	18	20
SAP	137409	137410	137411	137412
EAN	4051921589958	4051921589965	4051921589972	4051921589989
EUR/kos	16,10	19,10	26,20	29,10



Zaključek Burin				
SAP	132599			
EAN	3831054766096			
EUR/kos	86,90			

→ Svetli premer dimnika	14	16	18	20
-------------------------	----	----	----	----

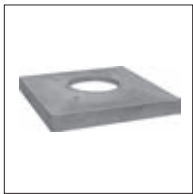

Betonska krovna plošča	14	16	18	20
SAP	132580	132583	132586	132589
EAN	3831054765914	3831054765945	3831054765976	3831054766003
EUR/kos	49,30	53,60	57,80	63,90



Vrečka za kondenz s sklopko				
SAP	900014779			
EAN	4051921809360			
EUR/kos	77,40			



ABS Diamantna rezalka	115 mm	230 mm
SAP	101871	101872
EAN	4037494088746	4037494088753
EUR/kos	49,30	121,40



Pokrov šamotni RA	16	18	20
SAP	100332	100333	100334
EAN	4037494018651	4037494018668	4037494018675
EUR/kos	10,30	11,70	13,20



PPL Prehod z UNI	14	16	18	20
SAP	111029	111284	111481	111693
EAN	4037494498729	4037494498736	4037494498743	4037494498750
EUR/kos	24,60	26,30	28,10	29,80
masa v kg	0,71	0,81	0,91	1,01

Pomembno:

■ Preverite našo tehnično dokumentacijo (slike so simbolične).

Obložni elementi za UNI ISO Plus in UNI Plus

Glede statične stabilnosti dimnika upoštevajte navodila za montažo oz. se posvetujte s tehnično službo Schiedel!

Obložni element je sestavljen iz strukturnih stranic v željeni barvi, krovne plošče in distančnih vijakov.

SAP 990000040
EAN 4051921541222









Struktura: opeka
Barva: opečno rdeča, klinker rdeča, manga, bela, črna



Struktura: omet
Barva: opečno rdeča, klinker rdeča, manga, bela, črna



Struktura: gladka
Barva: opečno rdeča, klinker rdeča, manga, bela, črna

Tip dimnika	Svetli Ø cm	Oznaka elementa	Zunanje mere plašča v cm	Zunanje mere obložnega elementa v cm	Višina cm							
					75	100	125	150	175	200	225	250
 Enojni	12	OE EZ 12-16	32/32	49/49	397,40	478,50	559,60	640,70	721,80	802,90	884,00	965,10
	14	OE EZ 12-16	32/32	49/49								
	16	OE EZ 12-16	32/32	49/49								
	18	OE EZ 18-20	36/36	49/49	418,30	503,30	588,30	673,30	758,30	843,30	928,30	1013,30
	20	OE EZ 18-20	36/36	49/49								
	25	OE EZ 25	48/48	67/67								
30	OE EZ 30	55/55	74/74	688,90	807,80	926,70	1045,60	1164,50	1283,40	1402,30	1521,20	
 Enojni z ventilacijo	12TL	OE EZL 12-16	32/46	49/67	430,10	513,70	597,30	680,90	764,50	848,10	931,70	1015,30
	14TL	OE EZL 12-16	32/46	49/67								
	16TL	OE EZL 12-16	32/46	49/67								
	18TL	OE EZL 18-20	36/50	49/67	454,80	539,80	624,80	709,80	794,80	879,80	964,80	1049,80
	20TL	OE EZL 18-20	36/50	49/67								
	25L	OE EZL 25	48/62	67/80								
	30L	OE EZL 30	55/71	74/86	656,10	769,90	883,70	997,50	1111,30	1225,10	1338,90	1452,70
 Dvojni	1212	OE ZZ 12-16	32/59	49/80	530,70	621,00	711,30	801,60	891,90	982,20	1072,50	1162,80
	1414	OE ZZ 12-16	32/59	49/80								
	1616	OE ZZ 12-16	32/59	49/80								
	1818	OE ZZ 18-20	36/67	49/80	539,90	631,40	722,90	814,40	905,90	997,40	1088,90	1180,40
	2020	OE ZZ 18-20	36/67	49/80								
 Dvojni kombinirani	12	OE ZZK 12-20	36/64	49/80	558,30	657,50	756,70	855,90	955,10	1054,30	1153,50	1252,70
	14	OE ZZK 12-20	36/64	49/80								
	16	OE ZZK 12-20	36/64	49/80								
	18	OE ZZK 12-20	36/64	49/80								
	20	OE ZZK 12-20	36/64	49/80								
 Dvojni z ventilacijo	12TL12	OE ZZL 12-16	32/72	49/99	535,90	626,10	716,30	806,50	896,70	986,90	1077,10	1167,30
	14TL14	OE ZZL 12-16	32/72	49/99								
	16TL16	OE ZZL 12-16	32/72	49/99								
	18TL18	OE ZZL 18-20	36/83	49/99	619,50	728,00	836,50	945,00	1053,50	1162,00	1270,50	1379,00
	20TL18	OE ZZL 18-20	36/83	49/99								
 Dvojni kombinirani z ventilacijo	12	OE ZZLK 12-20	36/81	49/99	600,00	704,50	809,00	913,50	1018,00	1122,50	1227,00	1331,50
	14	OE ZZLK 12-20	36/81	49/99								
	16	OE ZZLK 12-20	36/81	49/99								
	18	OE ZZLK 12-20	36/81	49/99								
	20	OE ZZLK 12-20	36/81	49/99								

Naročnik:	SCHIEDEL d.o.o. Latkova vas 82 3312 Prebold Slovenija
Za stranko / gradbišče:	T 03 703 82 00 F 03 703 82 65 info.si@schiedel.com www.schiedel.si
Telefon:	<input type="checkbox"/> Lasten prevoz <input type="checkbox"/> Dostava iz skladišča
Datum naročila:	Montaža: <input type="checkbox"/> Da <input type="checkbox"/> Ne

SCHIEDEL

Naročilo obložnega elementa št.:

Na podlagi posredovanih podatkov za dimnik _____ premera _____ naročamo _____ kos(ov) obložnih elementov.

Št. naloga:

Šifra izdelka:

Struktura:

- opečna
 omet
 gladka

Zaključek:

- konus
 omega
 z rozeto

Določanje višine elementa:
višina dimnika nad streho (h), zaokrožena na naslednjo večjo standardno višino

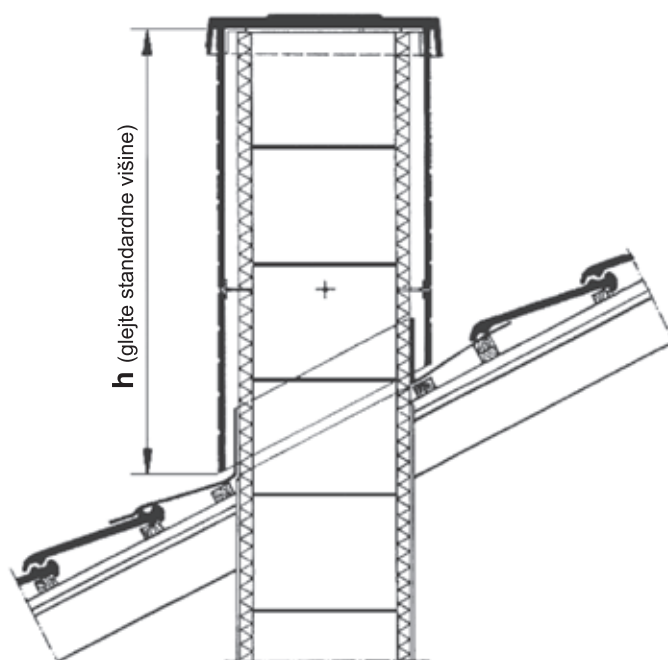

Barva:

- opečno rdeča
 klinker rdeča
 rjava
 bela
 antracit črna

Višina (cm):

- 75 175
 100 200
 125 225
 150 250

Naklon strehe: _____°

Opomba:

V primeru enojnega dimnika z zračnikom ali dvojnega kombiniranega dimnika označite položaj slemena z !

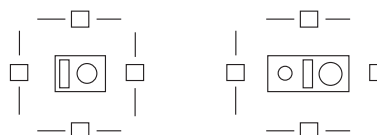

Naročnik s podpisom zagotavlja, da so podatki pravilni in s tem prevzema vse stroške, ki bi nastali zaradi netočnih podatkov.

Dobavni rok:

Podpis naročnika:

Podpis prodajnega referenta:

Pomembno:

- Preverite našo tehnično dokumentacijo (slike so simbolične).

UNI***Plus

Enojni Ø 25 - Ø 30 cm

Enojni z ventilacijo Ø 25 - Ø 30 cm

SCHIEDEL

UNI PLUS



→ Svetli premer dimnika	25	30	25L	30L
-------------------------	----	----	-----	-----



Dimnik UNI plus	Tip	UNI 25	UNI 30	UNI 25L	UNI 30L
Zunanja mera		48/48	55/55	48/62	55/71
Teža kg/m		187	240	229	325



Dimniški plašč UNI plus		25	30	25L	30L
33 cm, 3 kos/m	SAP	100357	100360	100368	100371
	EAN	4037494107317	4037494107324	4037494107362	4037494107379
	EUR/kos	27,90	30,50	30,50	37,70



UNI cev		25	30	25L	30L
33 cm, 3 kos/m	SAP	100310	100311	100310	100311
	EAN	4037494007976	4037494007983	4037494007976	4037494007983
	EUR/kos	43,40	52,20	43,40	52,20



Priključek za dimniška vratca		25	30	25L	30L
Višina 66 cm	SAP	100343	100344	100343	100344
	EAN	4037494045848	4037494045855	4037494045848	4037494045855
	EUR/kos	150,30	186,40	150,30	186,40



Priključek za peč pod kotom 90°		25	30	25L	30L
Višina 66 cm	SAP	100346	100347	100346	100347
	EAN	4037494046159	4037494046166	4037494046159	4037494046166
	EUR/kos	164,70	249,70	164,70	249,70



Priključek za peč pod kotom 45°		25	30	25L	30L
Višina 66 cm	SAP	100349	100350	100349	100350
	EAN	4037494046340	4037494046357	4037494046340	4037494046357
	EUR/kos	225,30	308,90	225,30	308,90

UNI***Plus

Enojni Ø 25 - Ø 30 cm

Enojni z ventilacijo Ø 25 - Ø 30 cm

SCHIEDEL

UNI PLUS



→ Svetli premer dimnika	25	30	25L	30L
-------------------------	----	----	-----	-----



Izolacijske plošče MAT plus	25	30	25L	30L
1 paket/m				
SAP	100541	100542	100541	100542
EAN	4051921733054	4051921573568	4051921733054	4051921573568
EUR/pkt	37,70	47,70	37,70	47,70



Kondenzna posoda z odvodom	25	30	25L	30L
SAP	175624	175625	175624	175625
EAN	4051921811851	4051921811868	4051921811851	4051921811868
EUR/kos	139,80	163,30	139,80	163,30



Konzolna plošča	25	30	25L	30L
SAP	100486	100489	-	-
EAN	4037494107782	4037494107799	-	-
EUR/kos	107,00	137,30	-	-



Krovna plošča za konusni nastavek UNI plus U	25	30	25L	30L
Za obzidavo, previs 15 cm				
SAP	103877	103878	-	-
EAN	4037494108000	4037494108017	-	-
EUR/kos	311,70	315,80	-	-



Krovna plošča za konusni nastavek UNI plus B	25	30	25L	30L
Za fasadno oblogo, previs 8,5 cm				
SAP	102492	102494	-	-
EAN	4037494802489	4037494802496	-	-
EUR/kos	311,70	315,80	-	-



Pritrdilni set za krovno ploščo	25	30	25L	30L
SAP		102003		
EAN		4037494055502		
EUR/kos		22,00		

Pomembno:

■ Preverite našo tehnično dokumentacijo (slike so simbolične).

UNI***Plus

Enojni Ø 25 - Ø 30 cm

Enojni z ventilacijo Ø 25 - Ø 30 cm

SCHIEDEL

UNI PLUS



Svetli premer
dimnika

25

30

25L

30L



Konusni nastavek UNI

	25	30	25	30
SAP	102584	102585	102584	102585
EAN	4037494088579	4037494088586	4037494088579	4037494088586
EUR/kos	105,50	117,10	105,50	117,10



Pokrov proti padavinam

	25	30	25	30
SAP	133794	133795	133794	133795
EAN	4051921478917	4051921478924	4051921478917	4051921478924
EUR/kos	81,00	86,00	81,00	86,00



Vratca Schiedel

	25	30	25L	30L
SAP	102785	102785	102785	102785
EAN	4049723011234	4049723011234	4049723011234	4049723011234
EUR/kos	72,50	72,50	72,50	72,50



Dilatacijska rozeta UNI

	25	30	25L	30L
SAP	132421	132603	132421	132603
EAN	3831054703121	3831054703145	3831054703121	3831054703145
EUR/kos	47,70	59,40	47,70	59,40

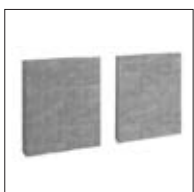

Izolacijski vložek

4 kosi za 1 RA priključek

	25	30	25	30
SAP	132445	132445	132445	132445
EAN	3831054703091	3831054703091	3831054703091	3831054703091
EUR/kos	4,60	4,60	4,60	4,60



Tesnilni kit Rapid

	25	30	25	30
SAP	100020	100020	100020	100020
EAN	4037494086124	4037494086124	4037494086124	4037494086124
EUR/kos	8,90	8,90	8,90	8,90
Poraba kos/m	0,80	1,00	0,80	1,00

Tehnične spremembe pridržane. Veljavnost cenika od 20. 3. 2024 do preklica.

UNI***Plus

Enojni Ø 25 - Ø 30 cm

Enojni z ventilacijo Ø 25 - Ø 30 cm

SCHIEDEL

UNI PLUS



Svetli premer
dimnika

25

30

25L

30L



Malta za zidanje plašcev 25 kg

SAP	132348
EAN	3831054716657
EUR/kos	11,70
Poraba kg/m	12,50



Nosilec izolacije

8 kosov za 1RA

SAP	132289
EAN	3831054702995
EUR/kos	1,60

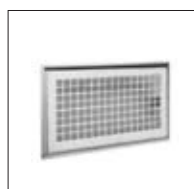

Ventilacijska rešetka

150 x 250 mm

SAP	102681
EAN	4037494090770
EUR/kos	20,40



Betonski podstavek

	25	30	25L	30L
SAP	100081	100160	100081	100160
EAN	4037494036150	4037494109328	4037494036150	4037494109328
EUR/kos	19,90	25,25	19,90	25,25

Pomembno:

Preverite našo tehnično dokumentacijo (slike so simbolične).

Ostali prodajni program



Šamotna malta 5 kg

SAP	132349
EAN	3831054749853
EUR/kos	15,30
Poraba kg/m ²	7



Vratca REPARATUR

23 x 36 cm

SAP	102798
EAN	4049723007930
EUR/kos	32,40



Ignis Protect

Za prehod dimovodov skozi stene iz gorljivih materialov (Absolut in UNI plus)
*samo za priključke pod kotom 90°

Opozorilo: testirano za vgradnjo dimnikov do Ø 180 mm

SAP	EAN	Debelina - D (mm)	Teža (kg)	Cena (EUR)
101840	4037494157459	100	4,0	177,40
101841	4037494157466	150	6,0	243,90
101842	4037494157473	200	8,4	294,40
101843	4037494157497	250	10,5	353,90
101844	4037494157510	300	12,5	387,00
101845	4037494160367	350	15,0	456,60
101846	4037494157534	400	16,7	504,50

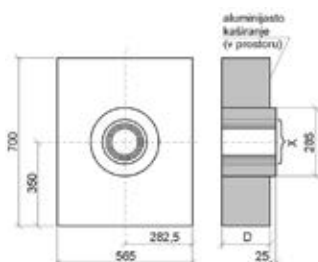

X – cevni vstavki
Ø 113, Ø 133, Ø 153, Ø 185

Opozorilo: Aluminijasto kaširanje na notranji strani stavbe; cevni vstavki so izvlačljivi; material: kamena volna, gostote 120 kg/m³; odziv na ogenj: A1 po SIST EN 13501-1.



PODROČNI VODJI PRODAJE - KERAMIČNI DIMNIKI

1. Jože Skok, GSM: 041 797 275

E-mail: joze.skok@schiedel.com

2. Broneta Sagmeister, GSM: 041 725 290

E-mail: broneta.sagmeister@schiedel.com

PODROČNI VODJA PRODAJE - NERJAVNI DIMNIKI

Primož Vilec, GSM: 031 646 359

E-mail: primoz.vilec@schiedel.com

INFORMACIJE NA:



SCHIEDEL

SCHIEDEL dimniški sistemi d.o.o.

Latkova vas 82

3312 Prebold

Slovenija

T 03 703 82 00

info.si@schiedel.com
www.schiedel.si

Sledite nam na:



A **stañdard**
INDUSTRIES COMPANY