



SCHIEDEL INSTALLER
REWARDS

SCHIEDEL

ICS

Installation Instructions

DON'T FORGET TO REGISTER YOUR INSTALLATIONS
AND START EARNING SCHIEDEL INSTALLER REWARDS
See inside for more details

www.schiedel.com/uk

SAP 940002195 - October 2021

Contents

Approvals.....	2
Design Guide.....	3
Prior to Installation	4
Connecting Flue Pipe	5-6
BS EN 15287-1.....	7-8
System Chimney.....	9-11
Installation Instructions.....	12-17
Double Wall Adjustable Starter Section	18-19
Offset Dimensions	20-21
Firestop Components.....	22-23
Support Components.....	24-27
Typical Installations.....	28-31
Protect Box	32
Support Components.....	33-35
System Design	36-38
Typical External Installations.....	39
Load Bearing Data.....	40
Component Weights.....	40
After Installation	41
Notice Plate.....	41
Product Guarantee.....	42
Schiedel Installer Rewards.....	42
Useful Guides.....	43

Approvals



ICS is CE Certified to EN1856-1 TÜV 0036 CPR 9195 001 with designations:
 ICS is CE Certified to EN1856-2 TÜV 0036 CPR 9195 041 with designations

High Temperature Applications EN1856-1		Low Temperature Applications EN1856-1	Connecting Flue Pipe EN1856-2
T450 N1 W V2 L50050 G60 T450 N1 D V3 L50050 G60 60mm distance to combustibles in a combustible shaft *	T450 N1 W V2 L50050 G50 T450 N1 D V3 L50050 G50 50mm distance to combustibles in a non combustible shaft or in free air *	T200 P1 W V2 L50050 O00 Zero distance to combustibles *	T450 NI D V2 L50050 G100M

* For full information please see p.8 - Distance to Combustibles Section

- Manufactured under a Quality Management Scheme approved to BS EN ISO 9001
- 4 Hour Fire Rating to BS476 Part 20
- Certified for corrosion resistance on gas, oil and solid fuel by Gastec, MPA and TÜV
- HETAS listed for use on solid fuel applications.

Design Guide

MANDATORY REQUIREMENTS

Connection to an appliance which is not connected to the fuel supply, should be carried out by a competent person. We recommend the use of HETAS approved installers for solid fuel applications. If installation is carried out by a non HETAS registered installer, the installation must be certified by a local Building Control inspector. Connection to an appliance that is connected to the fuel supply must be carried out by a Gas Safe (Gas) or OFTEC (Oil) registered installer.

The design guide must be read in conjunction with the detailed component installation instructions. For full design and installation details the key referral documents are:

- BS EN 1856-1: Chimneys - System Chimney Products
- BS EN 1856-2: Connecting Flue Pipes
- BS EN 1859: Metal Chimneys - Testing Methods
- BS EN 1443: Chimneys - General Requirements
- BS EN 15287-1: Chimneys. Design, installation and commissioning of chimneys. Chimneys for non-room sealed heating appliances.
- BS 5440-1: Fluing and ventilation for gas appliances of rated input not exceeding 70kW net (1st, 2nd and 3rd family gases).

Specification for installation of gas appliances to chimneys and for maintenance of chimneys.

- Approved Document J: - Combustion appliances and fuel storage systems (England & Wales)
- DFP Technical Booklet L: - Combustion appliances and fuel storage systems (NI)
- Technical Handbook (Domestic & Non Domestic), Section 3 - Environment (Scotland)
- Appliance Installation Instructions and related standards. Other standards covering specific applications will also be relevant and must be adhered to.

Planning permission may be required, and reference should be made to the local Building Control Department.

Ensure all chimney components are available and check them to ensure there has been no damage. Do not use damaged components. Build the chimney up through the previous designed route which should be as straight as possible.

Prior to Installation

VENTILATION

It is very important that sufficient air for combustion and ventilation is provided to the room containing the appliance, to enable correct and efficient working of the appliance and chimney system. Reference should be made to the appliance manufacturer's instructions and recommendations are also given in the Building Regulations Document J, CIBSE guidance notes and BS 5440.

CARBON MONOXIDE ALARMS

The carbon monoxide alarms should comply with BS EN 50291

Where a new or replacement fixed solid fuel appliance is installed in a dwelling, a carbon monoxide alarm must be provided in the room where the appliance is located.

Please follow manufacturer's instructions with regards to siting and fixing or alternatively :-

- a) On the ceiling at least 300mm from any wall or if it is located on a wall, as high up as possible (above any doors and windows), but not within 150mm of the ceiling and
- b) between 1m and 3m horizontally from the appliance.

N.B Provision of a carbon monoxide alarm should not be regarded as a substitute for correct installation and regular servicing.

PAINTING

If painting of any external sections is required, it is important to de-grease, dry and prime the exterior surface prior to the application of appropriate heat resistant paint. Schiedel Chimney Systems can provide to special order, chimney sections and accessories painted to an extensive range of British Standard RAL colours – details on application.

Please note that conditions in coastal areas means that corrosion is more likely to occur. Please contact us for advice on any such installation.

HANDLING

It is advised that suitable PPE should be used when handling the products.

DELIVERY TO SITE AND STORAGE

Components should be carefully transported and off loaded. They should be inspected to ensure they have not been damaged, and should be stored off the ground and under cover so that they are protected from accidental damage and the adverse effects of weather.

Connecting Flue Pipe

APPLIANCE/CHIMNEY CONNECTION

Connection to the appliance can be made using Prima Smooth, Prima Plus or alternative approved single wall connecting flue pipes, or ICS.

This must be done by using the appropriate appliance connector. When a single wall connecting flue pipe is used to connect an appliance to the chimney, the lower end of the chimney section must extend a minimum of 425mm below the ceiling. When connecting the appliance to the flue pipe all joints between the flue pipes/appliance outlet must be securely caulked and sealed with non asbestos rope (or suitable alternative) and fire cement on solid fuel appliances and using the appropriate lip seal gasket in the case of condensing appliances.

Any flue pipe connection to the chimney MUST be made in the same room as the appliance.

CONNECTION TO DRAUGHT DIVERTER

Where the appliance features a draught diverter the connection should rise vertically from it for at least 600mm before any change of direction (unless otherwise specified by the appliance manufacturer). This is in accordance with the recommendations contained in BS 5440 Part 1 section 4.1.5.

CONNECTING FLUE PIPE DIAMETER

The chimney size should be as recommended by the appliance manufacturer. Where there is a requirement for a flue diameter smaller than the appliance spigot, then the operational requirements of the appliance and the configuration of the flue must satisfy the flue sizing requirements of EN13384-1 for single appliances, and EN13384-2 for multi appliances.

DISTANCE TO COMBUSTIBLES

In accordance with building regulations, it is essential that the correct distance to combustible material is maintained on connecting flue pipes. On solid fuel applications, where there is a risk of soot fire, on unmeasured (NM) designated single wall product, this distance is $3 \times \text{Ø}$ Int of the pipe, e.g. for Ø130mm the distance is 390mm and for Ø150mm the distance is 450mm to combustibles on both painted and non painted variants. On measured (M) single wall or double wall products this distance will be as declared by the chimney manufacturer. On ICS25, when used as a connecting flue pipe, this distance has been measured and is set at 100mm.

Connecting Flue Pipe

CONNECTING FLUE PIPE ROUTE

Single wall connecting flue pipes should only be used to connect appliances to a Chimney. They should not pass through any roof space, partition, internal wall or floor, except to pass directly into a chimney through a wall of the chimney.

Connecting flue pipes should be located as to avoid igniting combustible material.

On solid fuel appliances the maximum length of a connecting flue pipe is 2m. This distance is reduced to 1.5m if any of the acceptable alternative methods of connection are adopted as per BS EN15287-1. (See p.5-6 for full details.)

On appliances with a top outlet, it is recommended that a vertical run of at least 600mm should be allowed immediately above the appliance prior to any change of direction.

On appliances with a rear outlet, it is recommended that there is maximum of 150mm in the horizontal run however under certain conditions, as described in alternative methods in BS EN 15287-1, this may be increased to 450mm. (See p.5-6 for full details.)

Within a system (Chimney + Connecting Flue Pipe) there should be no more than 4 changes of direction of maximum 45°. 90° Factory made bends or tees within the system may be treated as being equal to two 45° bends (as per Document J of the Building Regulations issued October 2010).

INSPECTION

On solid fuel applications to conform to Building Regulations, provisions should be made to enable a chimney to be inspected and cleaned.

An inspection pipe, inspection elbow or a 90° or 135° Tee with tee cap can form a suitable inspection point (unless cleaning/inspection can be done through the appliance). To aid cleaning, sufficient distance should be left between changes of direction to permit the safe passage of cleaning brushes within the system. This is particularly important on solid fuel applications. It is recommended that chimneys serving solid fuel appliances be swept as frequently as necessary, but at least twice a year.

BS EN 15287-1

Acceptable alternative Methods of connection

Where a horizontal connecting flue of more than 150mm is required to connect a solid fuel fired appliance to a chimney, an installation method as per the examples below may be used provided the following criteria is met:-

- a. The maximum length of horizontal connecting flue pipe does not exceed 450mm;
- b. A Defra exempt appliance or an appliance, which is limited to burning authorised smokeless fuel only, is installed;
- c. A calculation according to BS EN13384-1 has indicated safe operation of the proposed configuration, and the results of the calculation are left with the householder along with the appliance installation instructions;
- d. The appliance manufacturer agrees in writing to the proposed configuration;
- e. The chimney manufacturer agrees in writing to the proposed configuration;
- f. The total length of single wall connecting flue pipe is not more than 1.5m;
- g. The appropriate distances to combustible materials from both the appliance and the connecting flue pipe are maintained.

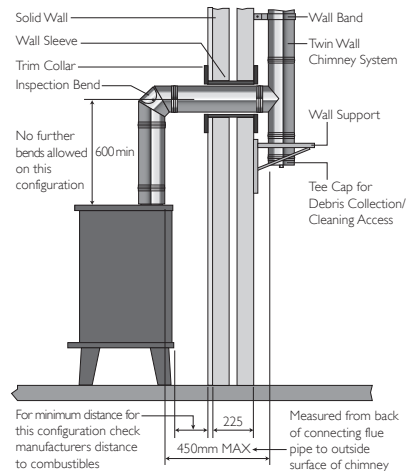
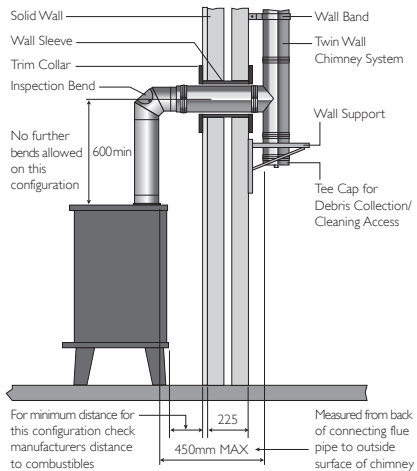

Top Outlet Single Wall Connecting Flue Pipe through Solid Wall into Twin Wall System Chimney

NB Where the connecting flue pipe from the appliance passes through any wall other than the existing chimney wall, the connecting flue pipe must be a System Chimney of twin wall insulated design.

Top Outlet Twin Wall Connecting Flue Pipe through Solid Wall into Twin Wall System Chimney

BS EN 15287-1

Acceptable alternative Methods of connection

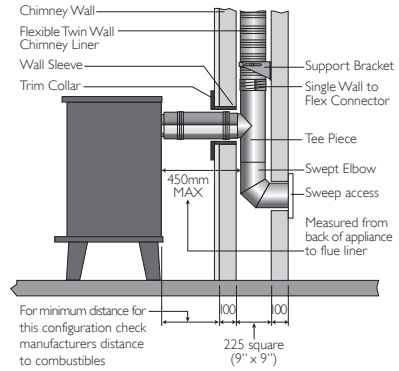
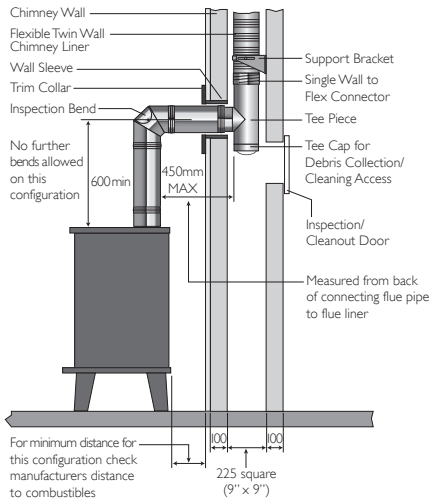

Top Outlet Twin Wall Connecting Flue Pipe into Re-lined Masonry Chimney

Rear Outlet Twin Wall Connecting Flue Pipe into Re-lined Masonry Chimney

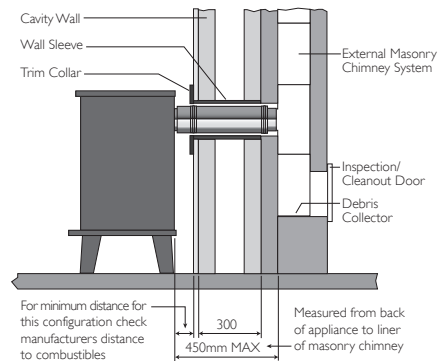
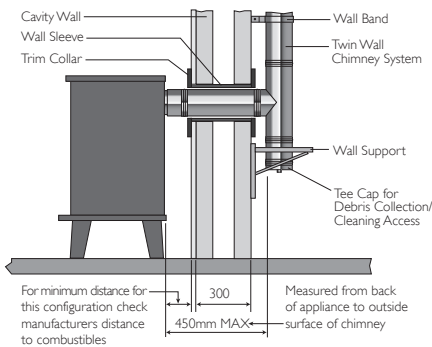

Rear Outlet Twin Wall Connecting Flue Pipe Through Cavity Wall into Twin Wall System Chimney

Rear Outlet Twin Wall Connecting Flue Pipe into External Masonry Chimney through a Cavity Wall

System Chimney

CHIMNEY DIAMETER

The chimney size should be as recommended by the appliance manufacturer. Where there is a requirement for a flue diameter smaller than the appliance spigot, then the operational requirements of the appliance and the configuration of the flue must satisfy the flue sizing requirements of EN13384-1 for single appliances, and EN13384-2 for multi appliances.

CHIMNEY ROUTE

The chimney should remain as straight as possible through its vertical run to assist flow. Should it be necessary to offset a chimney run then the following guidelines should be adhered to:

It is recommended that a vertical run of at least 600mm should be allowed immediately above the appliance prior to any change of direction. Within a system, on all fuels, there should be no more than 4 changes of direction of maximum 45°. Factory made 90° bends or tees within the system may be treated as being equal to two 45° bends (as per Document J of the Building Regulations issued October 2010).

CONNECTION TO DRAUGHT DIVERTER

Where the appliance features a draught diverter the connection should rise vertically from it for at least 600mm before any change of direction (unless otherwise specified by the appliance manufacturer). This is in accordance with the recommendations contained in BS 5440 Part 1 section 6.1.4

DIRECT CONNECTION APPLIANCE TO SYSTEM CHIMNEY

When connecting from the appliance directly to a system chimney, the appropriate appliance connector must be used and the joint between the appliance spigot and the appliance connector must be securely caulked and sealed with non asbestos rope (or suitable alternative) and fire cement on solid fuel appliances.

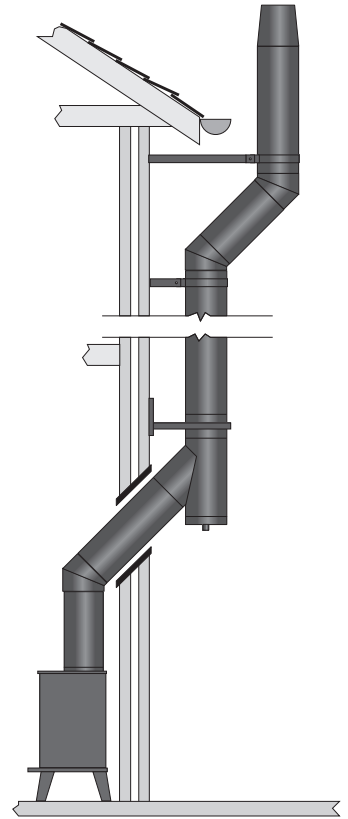

ICS direct connection from appliance

System Chimney

DISTANCE TO COMBUSTIBLES

In accordance with building regulations, it is essential that the correct distance to combustible material is maintained. On **solid fuel** applications, where there is a risk of soot fire, a distance of **60mm to combustibles** must be maintained within a **combustible floor** and within a **combustible shaft** (see Fig.1 below). There is no need to line the area within the floor cavity with plasterboard; however the **ventilated fire stop plate** and **ventilated support plate** must be used.

On **gas and oil** applications, a distance of **50mm to combustibles** must be maintained within a **combustible floor** and within a **combustible shaft**. The **ventilated fire stop plate** and **ventilated support plate** must be used.

Where the chimney penetrates a **non combustible** floor and where a **non combustible** shaft is used, a distance of **50mm to the shaft** is sufficient. In this case, **non ventilated fire stop plates** and support plates may be used with a **ventilated fire stop** being used where the chimney penetrates into the **roof space**.

On bungalow applications where the chimney runs through either a combustible or non-combustible ceiling, an unventilated bungalow fire stop plate kit can be used. Please note that an unventilated support plate can not be used above the ceiling in this case. The weight of the chimney should be supported using the roof support (see p.33). Distance to combustibles must be respected within the ceiling space (see Fig. 2 below) and mesh frame should be used within the loft space, which must be ventilated (see Fig. 2 below).

ENCLOSURE/SHAFTS

With the exception of the room containing the appliance, where the chimney passes through any part of the building, where there is a risk of accidental human contact, i.e a bedroom etc., or where there is a risk of contact with combustible materials stored in a cupboard or in the roof-space, the chimney must be enclosed in an appropriate way to meet Building Regulations. This can be achieved by boxing in the chimney in habitable rooms, or by the use of a protective wire mesh frame in roof spaces etc. In all cases the minimum distance to any combustible material, including loft insulation, must be respected according to the table on p.10, and any enclosure should be ventilated using the appropriate ventilated fire stops (see p.22).

Fig. 1

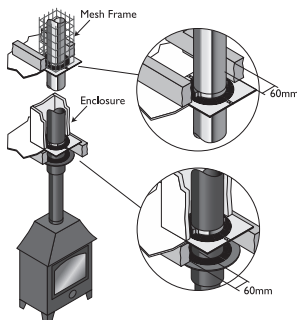

Internal House
Combustible Floors

Fig. 2

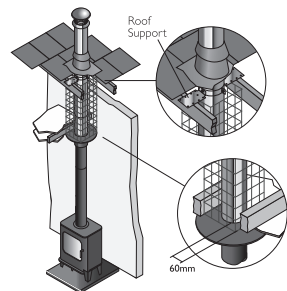

Internal Bungalow (Ventilated Loft Space)
Combustible and Non-Combustible Floors

System Chimney

SUPPORT COMPONENTS

The weight of a chimney system is considerable and requires independent support. Minimal weight should be borne by the appliance. The weight of the chimney can be supported from floor level by using a base support plate, or floor support; from the wall by using wall support top plates together with side plates or cantilever brackets; or from first floor level by using a support plate and clamp fixed to the floor/ceiling joists.

Wall brackets are non load bearing and provide lateral support only. Refer to the load bearing tables on page 40 for full details of maximum loadings.

Where the flue is freestanding above the roof and its height exceeds 1.5m above the last support or above the roof, a height of up to 3m can be achieved unsupported using the extended locking bands at the joint immediately below the last support and on each pipe joint above the last support.

Alternatively guy wire brackets can be used at the 1.5m level and every 1.5m thereafter in conjunction with guy wires, or rigid stays (provided by others).

CHIMNEY TERMINATION

For full information regarding to chimney termination, please refer to Annex M of BS EN 15287-1. As a guide please refer to page 36 of these installation instructions.

TERMINALS

All terminals must be secured with the use of a locking band. On solid fuel appliances, an open termination is normally recommended. However in certain conditions, rain caps or anti-downdraught terminals may be used.

Rain caps and anti-downdraught terminals are available in three versions, with anti-bird mesh, with spark guard, or without mesh. Where a terminal with mesh is used, there is a risk of soot build up, and therefore regular cleaning is required to avoid blockage, particularly when using oil or solid fuel.

Installation Instructions

JOINTING SYSTEM

All joints in the ICS chimney range, which require a locking band, are made by means of a simple push fit jointing method. This is achieved by the engineered spigot and socket system having a pronounced lead-in-edge to ease assembly.

ICS Plus is created by adding a lip seal gasket into the inward bead on the liner of the standard components, which are suitable for use in condensing applications with a P1 designation. When installing ICS Plus components, Gaskets should be fitted dry and lubricant applied to the internal of the female liner socket (see Fig.1 bottom of the page)

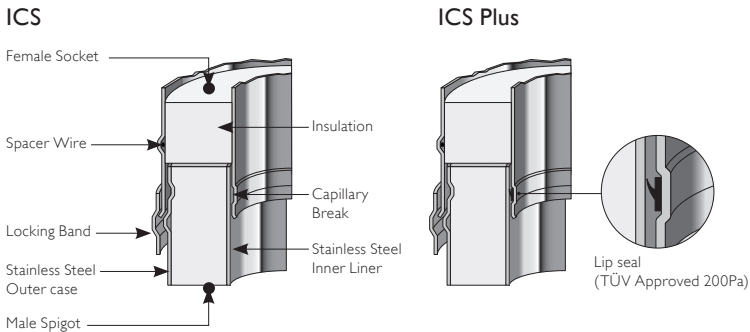

STANDARD CHIMNEY SECTIONS (PIPES, TEES AND ELBOWS)

Before assembling chimney sections, slip a locking band over female socket of the chimney section. Ensure the sections are pushed tightly together, before securing the locking band by use of the quick release clip. The clip can then be tightened into place by using the tightening bolt. Note:-joints must NOT occur within floor or ceiling spaces.

All flue gas carrying components must be installed with the direction arrow on the product label pointing to termination with the external male spigot of the case uppermost.

Fig. 1

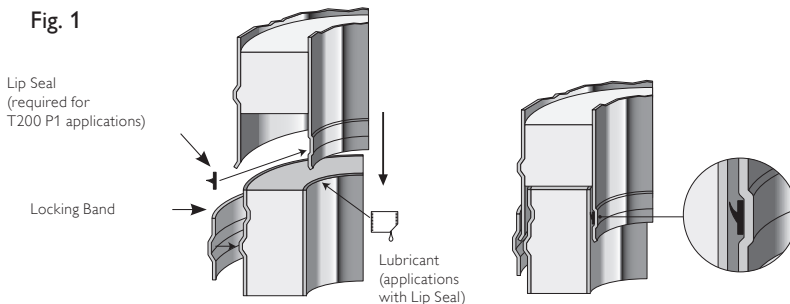

Installation Instructions

LOCKING BAND (SUPPLIED WITH EACH COMPONENT WITH A FEMALE SOCKET ON THE CASE)

A locking band must be fitted to every joint in the system. The band is of stainless steel construction and is fitted with a quick release clip and a stainless steel tightening bolt. The bolt can be adjusted to ensure the joint is firmly secured.

STRUCTURAL LOCKING BAND

The structural locking band, which is purchased separately, is used instead of a standard locking band in a situation where extra structural support is required, for instance where the chimney height is >1.5m above the last support or above the roof. It is also used to provide extra support in long horizontal runs. A maximum of 3m unsupported height can be achieved by fitting the structural locking band on the joint immediately below and on every joint above the last support. Please see diagram on page 39.

APPLIANCE CONNECTOR/STARTING CONNECTOR/STOVE STARTER PIPE

The protruding liner of these components should be pushed into the appliance spigot with the external male case spigot pointing upwards.

On solid fuel appliances the appliance connector should be sealed to the appliance with fire rope and fire cement or high temperature sealant to provide a gas tight joint. On condensing appliances the appropriate lip seal should be used.

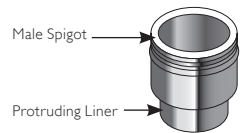

Appliance Connector

ADAPTORS FROM PRIMA PLUS & PRIMA SMOOTH TO ICS

These components are used to convert from a single wall connecting flue pipe to the ICS system chimney. The protruding liner should be pushed down inside the female socket of the connecting flue pipe, with the double wall external case spigot pointing in the direction of the flue gases.

Installation Instructions

ADAPTOR TO FLEX/TECNOFLEX PLUS

This component is used to convert from ICS to Flex/TecnoFlex Plus. The Flex/TecnoFlex Plus is pushed down inside the upstand on the adaptor; secured using self tapping screws and sealed with fire cement and fire rope to provide a gas tight joint.

ADAPTOR FROM ICS TO PRIMA PLUS

This component is manufactured with an ICS female socket and a Prima Plus female socket, and is used where there is a requirement to convert from ICS to Prima Plus. The ICS female socket should be attached to the previous ICS component and the joint secured using the locking band provided.

INCREASER

This component is used to increase from one diameter to the next diameter (e.g.) 200mm to 230mm. The component is fitted in the same way as a standard pipe length and should be secured with the locking band provided.

ANCHOR PLATE

When commencing an installation with a fire chest, hood or similar an anchor plate with plain end should be used. When extending an existing brick or masonry chimney stack, an anchor plate must be used which needs to be lined with a TecnoFlex Plus Liner then the anchor plate with the screw fit connection should be used. The liner of the Anchor Plate should be pushed into the opening of the fire chest with the plate resting on a bed of fire cement. The plate should then be fixed onto the concrete slab by masonry screws fitted through the pre-drilled holes in the plate.

In the case of a chimney extension, the liner of the anchor plate fits down inside the existing chimney stack. If a TecnoFlex Plus chimney liner is being used then the anchor plate is secured to the liner by twisting in a clockwise direction. The plate should then be bolted to the top of the existing chimney and sealed using fire cement.

Installation Instructions

ADJUSTABLE PIPE

The adjustable pipes are delivered as two pre-assembled sections with a joint band and locking band (see Fig.1). They are used with standard components to achieve an exact length on site and avoid on-site cutting of components.

1. Calculate the length required. Loosen the joint band and remove the top section of the adjustable pipe.
2. Remove insulation as required to achieve the correct length.
3. Re-assemble the pipe and cover the joint with the joint band.
4. Fix the adjusted section to standard components using the locking band provided.

Please note that the adjustable pipe is non load bearing.

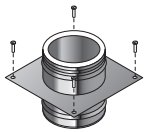

Anchor Plate

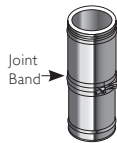

Adjustable Pipe

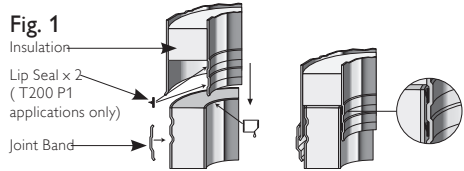
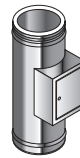

Fig. 1

Installation Instructions

INSPECTION LENGTH (DRY SYSTEMS)

The inspection length is a component providing the facility for flue inspection and cleaning. It is installed as per a standard pipe section.



Inspection Length
(Dry Systems)

INSPECTION LENGTH (CONDENSING SYSTEMS)

The inspection length is a component providing the facility for flue inspection and cleaning on condensing or high efficiency appliances with a maximum flue gas temperature of 250°C, and a positive pressure rating of up to 200 Pa. It is installed as per a standard pipe section.



Inspection Length
(Condensing Systems)

INSPECTION PIPE

The Inspection pipe is a component which provides the facility to inspect the flue. It is installed as per a standard pipe section.

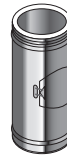

Inspection Pipe

MEASURE PIPE

The measure pipe is a component which provides access to the flue for draught testing or for flue gas analysis. It is installed as per a standard pipe section.

VERTICAL DRAIN PIPE

This component is used on condensing systems and provides the facility to collect and drain off condensate from the chimney. It is installed in the same way as a standard pipe. It is provided as standard with a 3/4" BSP fitting.

SW-DW ADJUSTABLE STARTER SECTION

The protruding male spigot of the adaptor slides down inside the female socket of the Prima Smooth pipe and the socket of the Prima Smooth pipe slides within the conical section of the starter adaptor, to a maximum length of 75mm into the cone with a minimum of 15mm to ensure a secure connection.

This maximum length of 75mm will leave sufficient space within the adaptor to allow for thermal expansion of the single wall pipe and also to allow for the connecting flue pipe to be removed without cutting, if the appliance has to be moved for servicing.

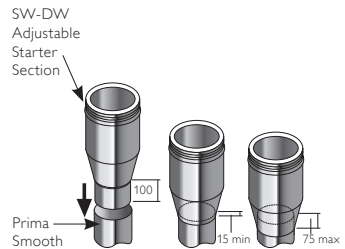

Installation Instructions

ELBOWS AND 90° INSPECTION ELBOWS

For offset information on standard elbows, please refer to p.14

Please note that 90° Inspection bends may be incorporated into a connecting flue pipe arrangement on all fuels, please refer to National Annex of BS EN 15287-1 for specific guidance re use on solid fuel applications, the diagrams on p.7-8 give guidance.

In cases of top mounted stoves, a minimum vertical height of 600mm from the appliance must be respected prior to any change of direction in the flue pipe.

90° TEE

This component may be used to connect from a connecting flue pipe to the vertical system chimney at 90° or the branch may be used to locate a draft stabiliser. It is installed as per a standard pipe section.

Int Ø	80	100	130	150	180	200	230	250	300
Ext Ø	130	150	180	200	230	250	280	300	350
A	145	155	170	180	195	205	220	230	258
B	250	270	305	325	355	375	405	425	480
C	145	155	170	180	195	205	220	230	258

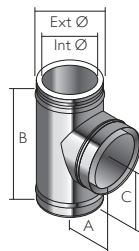

90° Tee

93° TEE

This component must be used in place of a 90° tee to connect from a connecting flue pipe to the vertical System Chimney on condensing systems to ensure that condensate can drain down through the system to a drain point. This component is installed as per a standard pipe section.

Int Ø	80	100	130	150	180	200	230	250	300
Ext Ø	130	150	180	200	230	250	280	300	350
A	-	162	178	189	206	216	233	244	264
B	-	278	309	329	359	379	405	455	490
C	-	166	178	189	206	216	233	257	268

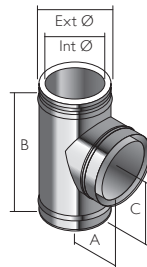

93° Tee

135° TEE

This component may be used in combination with a 45° elbow to connect from a connecting flue pipe to the vertical system chimney. It is installed as per a standard pipe section and provides the least resistance to the flow of the flue gases.

Int Ø	80	100	130	150	180	200	230	250	300
Ext Ø	130	150	180	200	230	250	280	300	350
A	-	262	298	322	358	382	419	443	509
B	-	327	375	403	445	474	516	544	622
C	-	262	298	322	358	382	419	443	509

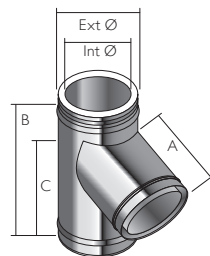

135° Tee

Double Wall Adjustable Starter Section

Initial installation

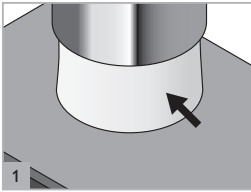

1 Remove loose strip of insulation and keep to one side.

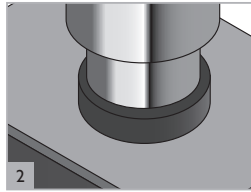

2 Insert male spigot of liner into the appliance spigot.

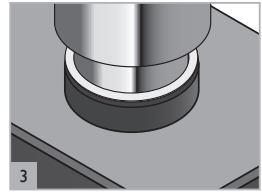

3 Seal using the rope gasket, fire cement or similar.

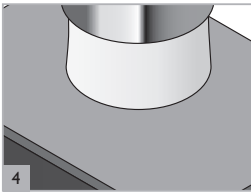

4 Insulate liner using strip of insulation with joint to rear. Width of insulation can be trimmed to suit.

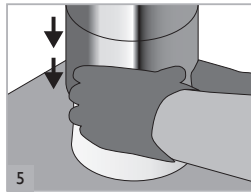

5 Slide adjustable case down over the insulation to cover the appliance spigot.

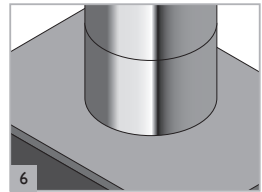

6 Finished installation.

Removal of stove for servicing

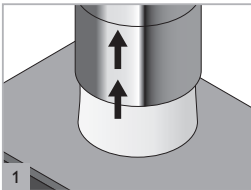

1 Slide adjustable case up inside the outer wall of the chimney.

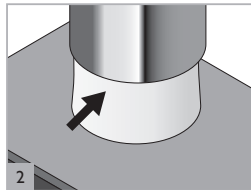

2 Remove two loose insulation strips and keep to one side.

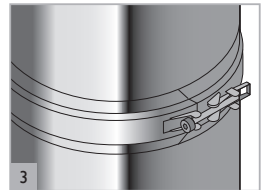

3 Loosen the locking band on the liner using the quick release clip (retain the locking band to one side).

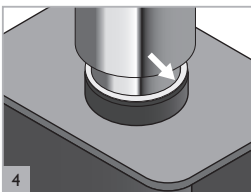

4 Break the fire cement seal between the appliance spigot and chimney liner.

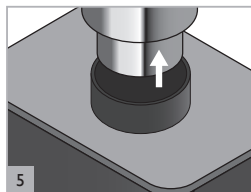

5 Slide the liner spigot up inside the chimney until clear of appliance spigot.

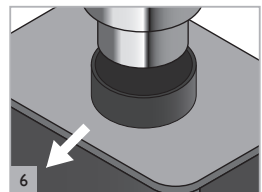

6 Remove the appliance.

Double Wall Adjustable Starter Section

Re-installation of stove after servicing

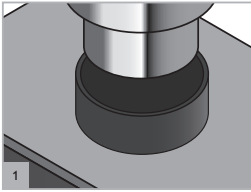

1
Position stove spigot immediately beneath liner spigot of chimney.

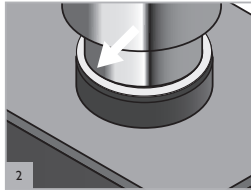

2
Slide liner spigot down inside the appliance spigot and seal using the fire cement, rope gasket or similar.

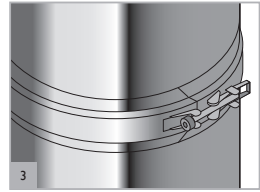

3
Slide locking band into place around the joint on the liner. Now tighten the bolt on the locking band around the joint of the liner.

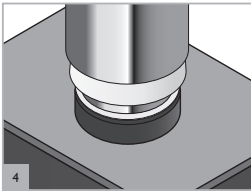

4
Position narrower strip of insulation around the locking band with joint to the rear.

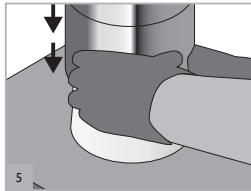

5
Slide adjustable cover down 5mm past insulation. Position final insulation around spigot with joint to the rear.

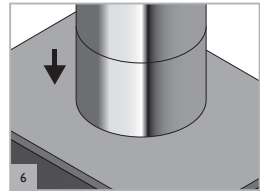

6
Slide adjustable case down over the insulation to cover the appliance spigot.

Offset Dimensions

(made by assembling 2 bends)

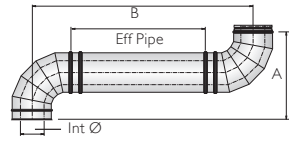
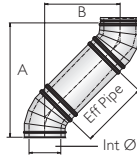
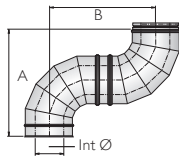
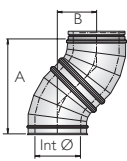

Offsets for Double 15° Bend

Int Ø	80	100	130	150	180	200	230	250	300
A	295	295	295	295	315	315	315	334	334
B	39	39	39	39	41	41	41	44	44

Offsets for Double 30° Bend

Int Ø	80	100	130	150	180	200	230	250	300
A	280	299	327	336	355	373	373	392	411
B	75	80	88	90	95	100	100	105	110

Offsets for Double 45° Bend

Int Ø	80	100	130	150	180	200	230	250	300
A	307	324	341	358	376	393	427	427	461
B	127	134	141	148	156	163	177	177	191

Offsets for Double 90° Bend

Int Ø	80	100	130	150	180	200	230	250	300
A	300	316	348	366	396	420	452	468	518
B	300	316	248	366	396	420	452	468	518

Offsets for 135 Tee° & 45° Bend

Int Ø	80	100	130	150	180	200	230	250	300
A	343	370	437	445	452	496	523	537	592
B	305	324	404	406	415	473	475	499	556

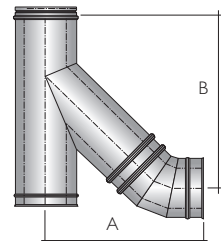

Offset Dimensions

(made by assembling 2 bends)

Double 15° Bend C/W Pipe Length										
Int Ø		80	100	130	150	180	200	230	250	300
955 Eff Pipe	A	1218	1218	1218	1218	1238	1238	1238	1257	1257
	B	286	286	286	286	288	288	288	291	291
455 Eff Pipe	A	735	735	735	735	755	755	755	774	774
	B	157	157	157	157	159	159	159	162	162
205 Eff Pipe	A	493	493	493	493	513	513	513	532	532
	B	92	92	92	92	94	94	94	97	97
150 Eff Pipe	A	445	445	445	445	465	465	465	484	484
	B	79	79	79	79	81	81	81	84	84

Double 30° Bend C/W Pipe Length										
Int Ø		80	100	130	150	180	200	230	250	300
955 Eff Pipe	A	1107	1126	1154	1163	1182	1200	1200	1219	1238
	B	553	558	566	568	573	578	578	583	588
455 Eff Pipe	A	674	693	721	709	765	765	784	784	793
	B	303	308	316	318	323	328	328	333	338
205 Eff Pipe	A	458	477	505	514	533	551	551	570	589
	B	178	183	191	193	198	203	203	208	213
150 Eff Pipe	A	414	433	461	470	489	507	507	526	545
	B	153	158	166	168	173	178	178	183	188

Double 45° Bend C/W Pipe Length										
Int Ø		80	100	130	150	180	200	230	250	300
955 Eff Pipe	A	982	999	1016	1033	1051	1068	1102	1102	1136
	B	802	809	816	823	831	838	852	852	866
455 Eff Pipe	A	629	646	663	680	698	715	749	749	783
	B	449	456	463	470	478	485	499	499	513
205 Eff Pipe	A	452	469	486	503	521	538	572	572	606
	B	272	279	286	293	301	308	322	322	336
150 Eff Pipe	A	417	434	451	468	486	503	537	537	571
	B	237	244	251	258	266	273	287	287	301

Double 90° Bend C/W Pipe Length										
Int Ø		80	100	130	150	180	200	230	250	300
955 Eff Pipe	A	296	315	345	366	415	414	445	464	518
	B	1251	1270	1300	1321	1370	1369	1400	1419	1473
455 Eff Pipe	A	296	315	345	366	415	414	445	464	518
	B	751	770	800	821	870	869	900	919	973
205 Eff Pipe	A	296	315	345	366	415	414	445	464	518
	B	501	520	550	571	620	619	650	669	723
150 Eff Pipe	A	296	315	345	366	415	414	445	464	518
	B	446	466	495	516	565	564	595	614	673

Firestop Components

VENTILATED SUPPORT PLATE (GALVANISED WITH S/S BAND)

The support plate is used where the chimney passes through a combustible floor, and the weight of the chimney has to be taken at floor level. The support plate must be firmly fixed by using bolts or screws. For load bearing Data refer to tables 1 and 2 on page 40.

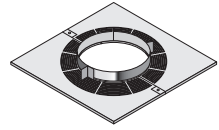

1. Frame a four sided level square opening within the joists using timber stringers where necessary to allow for the correct distance to combustibles from the outer wall of the chimney. This distance must be a minimum of 50mm on Gas and Oil applications and 60mm for solid fuel applications (see Fig. 3 below - distance x).
2. Lower the chimney section through the opening in the floor, and secure to the next section of pipe.
3. Locate the two halves of the support plates around the chimney section, and secure to the joists using screws or bolts.
4. Remove the screws which are fastened to the clamp band. Then fasten clamp band around the chimney section and position on top of the plate. Tighten using the nuts and bolts provided.
5. Using the holes in the clamp support ring drill 3mm holes in the outer casing of the chimney section (drill bit should be set for a depth no greater than 10mm to avoid damage to the liner).
6. Using the screws provided secure the clamp support ring to the outer casing of the chimney section.

Note: Joints must NOT occur within the floor or ceiling joists.

Ventilated Firestop Plate

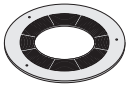

Non-Ventilated Bungalow Firestop

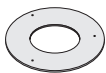

Fig. 2

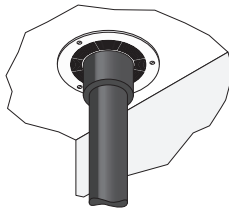

Fig. 3

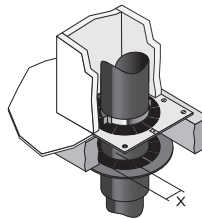
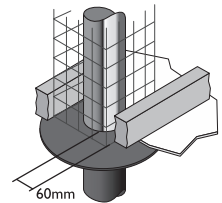

Fig. 4



Firestop Components

VENTILATED FIRESTOP PLATE (1 & 2-PIECE ROUND AND 2-PIECE RECTANGULAR)

The ventilated fire stop plates are used in combination with standard ICS pipes where the chimney passes through a combustible floor or ceiling. The outermost circle of ventilation slots gives a distance to combustibles of 60mm. This measures the required distance for solid fuel applications. For gas and oil applications a minimum of 50mm is required, which should be measured on site. The fire stop plate should be positioned around the chimney and fastened to the pre-cut plasterboard or to the timber frame with nails or screws using the location holes provided (see Fig. 2 above).

NON-VENTILATED BUNGALOW FIRESTOP (1 & 2-PIECE ROUND AND 1-PIECE RECTANGULAR)

Installed as per a ventilated firestop using the location holes provided (see Fig.4 above). Distance to combustibles must be respected - see p.8 for further info.

SUPPORT PLATE WITH S/S CLAMP BAND (NON COMBUSTIBLE FLOOR)

The support plate is used where the chimney passes through a non combustible floor, and the weight of the chimney has to be taken at floor level. The support plate must be firmly fixed to the floor using bolts or screws provided by others. For load bearing Data refer to table on page 40.

FIRE STOP PLATE (NON COMBUSTIBLE FLOOR)

This fire stop plate is used exclusively where the chimney passes through a non combustible floor. The two halves of the plate are located around the chimney section and fastened to the floor using bolts or screws provided by others.

Support Components

WALL BAND (60MM)

Internal and External Application

The wall band is supplied in three parts, two stainless steel split bands which fit tightly around the outside of the chimney and a stainless steel back bracket. The parts are joined together by means of the nuts and bolts provided. The use of the item maintains a fixed distance of 60mm depending on the wall band type chosen from the outer casing of the chimney to the wall or fixing point.

1. Once the position of the support has been determined, secure the back bracket to the wall with a method of fixing to ensure adequate attachment and support.
2. The stainless steel split band is then positioned around the chimney section and secured with the nuts and bolts provided to the back bracket.
3. The wall bracket provides lateral stability only, it is NOT load bearing and is to be positioned at 3 metre centres.

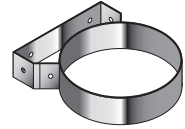

Wall Band
(60mm)

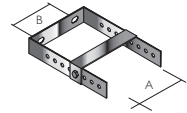

Adjustable Back
Bracket 60-
300mm

ADJUSTABLE BACK BRACKET 60-300MM

Internal and External Application

The adjustable wall bracket is supplied in three parts, a 'U' shaped stainless steel adjustable section, two bolts for fixing the wall band to the back bracket and a strengthening cross bracket.

4. Once the position of the support has been determined, secure the U shaped bracket to the wall with a method of fixing to ensure adequate attachment and support.
5. Determine the amount of extension required and secure the back bracket of the wall band in place onto the adjustable section.
6. Fasten the strengthening cross bracket in place using the bolts provided.
7. With the back bracket in place, locate the rear portion of the band onto the back bracket, the outer part of the band is then positioned around the chimney section and secured with the nuts and bolts provided.
8. The adjustable wall band provides lateral stability only, it is NOT load bearing and is to be positioned at 3 metre centres.

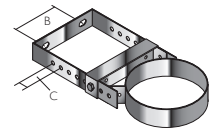

Wall Band and
Adjustable
Back Bracket
Assembly

Int Ø	80	100	130	150	180	200	230	250	300
Ext Ø	130	150	180	200	230	250	280	300	350
A	131	151	181	201	231	251	281	301	351
B	72	81	112	132	162	182	214	232	283
C	25	25	25	25	25	25	25	25	30

Support Components

STRUCTURAL WALL BAND

The structural wall band is supplied in two parts, a stainless steel split band which fits tightly around the outside of the chimney and a stainless steel back bracket. The parts are joined together by means of the nuts and bolts provided. The use of the item maintains a fixed distance of 50mm from the outer casing of the chimney to the wall or fixing point. It can be used in combination with the structural wall band extension components to provide for adjustment to various distances from the wall.

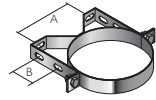

Structural Wall Band

1. Once the position of the support has been determined, secure the back bracket to the wall with a method of fixing to ensure adequate attachment and support.
2. The stainless steel split band is then positioned around the chimney section and secured with the nuts and bolts provided to the back bracket.
3. The wall bracket provides lateral stability only, it is NOT load bearing and is to be positioned at maximum 4 metre centres.

Int Ø	80	100	130	150	180	200	230	250	300
Ext Ø	130	150	180	200	230	250	280	300	350
A	100	120	150	170	200	220	250	270	320
B	55	55	55	55	55	55	85	85	85

STRUCTURAL WALL BAND EXTENSIONS

Available in 3 different sizes. Type W1 gives adjustment of between 55-100mm from the wall. L1 gives adjustment of between 100-250mm from the wall and L2 gives adjustment of between 100-440mm from the wall.

1. Once the position of the support has been determined, secure the back bracket to the wall with a method of fixing to ensure adequate attachment and support.
2. Fasten the structural wall band to the extension brackets using the nuts and bolts provided.

Int Ø	80	100	130	150	180	200	230	250	300
Ext Ø	130	150	180	200	230	250	280	300	350
C	174	194	224	244	274	294	324	344	394
D	180	200	230	250	280	300	330	350	400
E	110	110	110	110	110	110	110	110	110

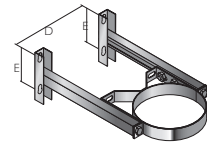

Structural Wall Band with Types L1 & L2 Extension Assembly

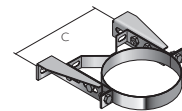

Structural Wall Band with Type W1 Extension Assembly

Support Components

LOAD BEARING SUPPORTS

All wall supports and floor supports are designed to provide load bearing support for the chimney. They must be used in combination with the relevant lateral support components, wall bands, guy wire brackets or telescopic roof stays as appropriate. See p.39 for further information.

BASE SUPPORT PLATE WITH DRAIN

This component is used to support the chimney directly from the floor. It should be fastened securely to the floor using bolts or screws provided by others.

RETROFIT WALL SUPPORT

- Lower the clamp band over the pipe length with the joint facing the wall.
- On the joint, ensure that the spring washer is between plain washer and the bolt head,
- Tighten the two fixing bolts on the clamp band using a torque wrench up to a minimum of 10 Nm (Newton-Meters).
- Attach the side brackets to the fixing bolts on the side of the band, but don't tighten.
- Attach the side brackets to the wall using a method of fixing to ensure adequate attachment and support, i.e. shield anchors.
- Mark up the hole positions for the brackets on the wall.
- Fix the brackets to the bolts on the side of the clamp band using the locking nuts provided.
- For maximum height of chimney see details on p. 40 onwards.

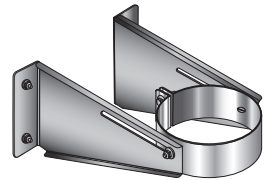

Side Plates

ADJUSTABLE TOP PLATE

The wall support is designed to be used internally or externally to provide either initial or intermediate support for the vertical chimney. It is used in combination with side plates or with cantilever brackets. The turned down edge at the front of the plates is slotted to allow for the plate to slide along the cantilever brackets and give some positional adjustment. The female socket on the pipe attached to the underside of the plate should be pushed down onto the preceding pipe and the joint secured using the locking band provided. The top plate is then attached to the side plates or the cantilever brackets using the bolts provided through the fixing slots in the top plate (see Fig. 1). The bolts should then be tightened firmly.

For maximum height of chimney see load bearing details, please refer to tables and diagrams on page 39 and page 40.

Fig.1 Top Plate

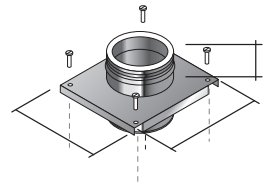

Int Ø	80	100	130	150	180	200	230	250	300
A	188	208	238	258	278	285	315	335	385
B	246	266	296	316	346	366	396	416	471

Support Components

SIDE PLATES/CANTILEVER BRACKETS

Once the position of the support has been established in relation to the chimney route, secure the side plates or cantilever brackets to the wall using expansion bolts to ensure adequate attachment and support (see Fig. 2).

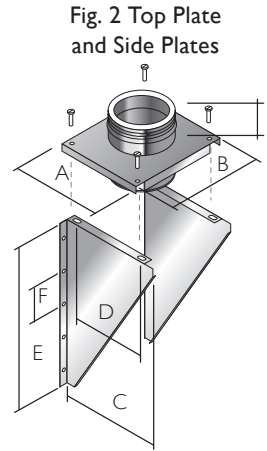

Wall Support Side Plates									
Int Ø	80	100	130	150	180	200	230	250	300
C	215	235	265	285	315	335	365	385	440
D	145	165	195	215	245	265	295	315	370
E	470	470	470	470	470	470	470	470	470
F	100	100	100	100	100	100	100	100	100

Cantilever Supports			
Type	325	475	570
Ø Range	80-200	80-300	80-300
C	325	475	570
D	242	242	330

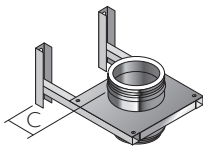

Cantilever Support Adjustment

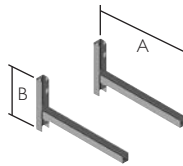

Cantilever Brackets - Types 325, 475

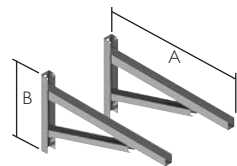

Cantilever Bracket - Type 570, 720, 820, 1104, 1120

Cantilever Support Adjustment									
Int Ø	80	100	130	150	180	200	230	250	300
C max									
Type 325	184	164	134	114	84	64	-	-	-
Type 475	334	314	284	264	234	214	184	164	114
Type 570	429	409	379	359	329	309	279	259	209
Type 720	579	559	529	509	479	459	429	409	359
Type 820	679	659	629	609	579	559	529	509	459
Type 1104	863	843	813	793	763	743	713	693	643
Type 1120	979	959	929	909	879	859	829	809	759
C min									
All Types	50	50	50	50	50	50	50	50	50

Typical Installations

Ignis-Protect

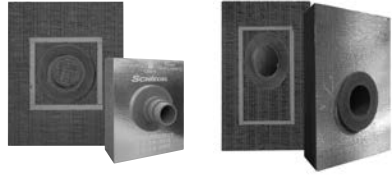

IMPORTANT!

Window and door lintels and their support areas, as well as other bearing elements must not be weakened! In case of uncertainty consult a structural engineer.

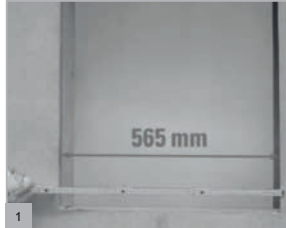

1 Clear installation width required 565mm.



2 Clear installation height of 700mm on 90° version, 1020mm on 45° version for walls between 100 - 200mm thick, and height 1320mm on walls between 250 - 500mm thick.



TIP:

The dimensions of the IGNIS-PROTECT wall bushings have already been matched to the standard centre-to-centre dimensions of wooden stud walls!



3 Remove plasterboard.
NOTE: The vapour barrier must not be damaged!

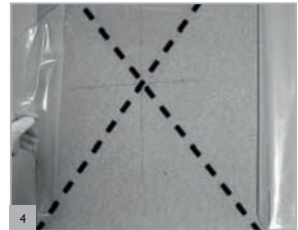

4 Cut a cross shape in the vapour barrier to the required dimensions of the opening (see figs. 1. and 2.)



5 Make the opening. **NOTE: Load bearing elements must not be weakened!** **IMPORTANT: follow the safe working notes on page 31.**



6 Remove wood fibre board, thermal insulation etc. from the assembly opening.



7 Install the wooden surround for Ignis-Protect into the studwork.

Typical Installations

Ignis-Protect

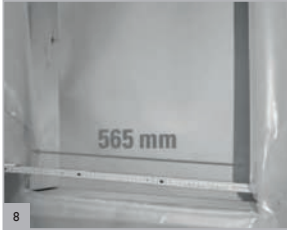

Check width of the opening: 565mm
NOTE: Ignis-Protect must not be shortened on site!



Check height of the opening (see image 2.) **NOTE: Ignis-Protect must not be shortened on site!**



If necessary correct the opening. Replace the thermal insulation right around the assembly opening in the studwork. **IMPORTANT: follow the safe working notes on page 29.**

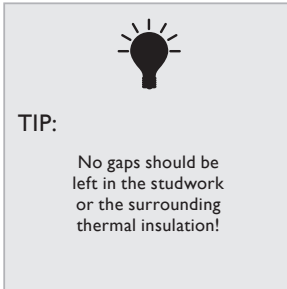

Open up the exterior wall.



Insert Ignis-Protect so that it fits perfectly. The side laminated with foil should be facing inwards!



With Ignis-Protect in place, cut away the vapour barrier flush to the edges.



Secure the junctions with the vapour barrier by applying appropriate sealing tape to the foil lamination.



View of the finished vapour barrier sealed tightly all round.

Typical Installations

Ignis-Protect



Cut a hole in the thermal board to fit the Ignis-Protect outer protection pipe. **IMPORTANT: follow the safe working notes on page 31.**



Replace the prepared thermal board. **NOTE: The vapour barrier must not be damaged!**



TIP:

The Ignis-Protect inner protection pipe and the outer protection pipe are basically designed for 24mm wall planking!



If necessary, shorten the inner and outer protection pipes to be flush with the wall. **IMPORTANT: follow the safe working notes on page 31.**

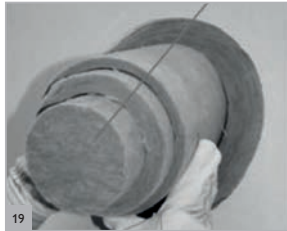

By pulling out the corresponding inner protection pipes and the assembly cap (A) the connection size is adapted to fit the required connecting pipe or transition piece.



TIP:

The inner protection pipes and the assembly cap (A) remain in place until the stove connection pipe is in its final position in the Ignis-Protect.



Check that the thermal insulation is flush with the wall.



IMPORTANT!

Follow the preparation guidelines and relevant drying times of the render system manufacturer!



Application of render over the whole surface. **NOTE: do not render over the inner protection pipe!**

Typical Installations

Ignis-Protect



Example of a design with a double-walled connecting flue pipe.

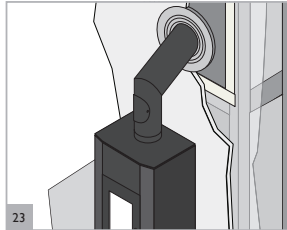

Finished installation.

HEALTH & SAFETY INSTRUCTION

Many building products, including chimney elements are manufactured using natural raw materials which contain proportions of crystalline quartz.

During the mechanical processing of products, such as cutting and drilling, quartz dust is released which can get into the lungs. With higher levels of exposure over longer periods this may result in damage to the lungs (silicosis) and as a consequence of the silicosis disease, to an increased risk of lung cancer.

THE FOLLOWING PROTECTIVE MEASURES ARE TO BE TAKEN

- When cutting and drilling, a P3/FFP3 respiratory protection mask is to be worn.
- In addition, wet-cutting equipment or equipment with dust extraction should be used.

HAZARDS FOR PEOPLE AND THE ENVIRONMENT

Mineral wool insulation materials in this group of products can release fine fibres which may have carcinogenic effects in the lungs. If inhaled, fibres can get into the body and cause damage to health. Larger fibres or fragments of fibres can cause irritation (itching) of the skin, the upper airways and the eyes!

PROTECTION MEASURES AND SAFE PRACTICE

Avoid contact with the skin!

After finishing work, rinse off dust with water and change your clothes. Wash exposed areas of skin thoroughly with soap and if necessary use a skin care product!



Protection measures are required when cutting and drilling. Wet-cutting or dust extraction should be used.



P3/FFP3 Respiratory Protection Mask



Eye Protection



Ear Protection



Eye Protection

When working overhead and where large amounts of dust are produced, wear goggles with side protection.



Hand Protection

Protective gloves, e.g. in leather or nitrile-coated cotton.



Breathing

For low-level activities (exposure category E1/E2) the use of half or quarter masks with P2 filters (white) or FFP2 particle filtering half masks is recommended.

Protect Box

NEW HOUSING AIRTIGHTNESS REQUIREMENTS

Schiedel provide an air tight sealing kit to prevent leakage where the chimney passes through vapour and/or wind barriers. This sealing kit is used in conjunction with our ICS50 System Chimney. The use of 50mm insulation ensures that the outer skin temperature on the chimney remains low enough for the EPDM kit to maintain its elasticity, and remain tight around the ICS50 product, ensuring the air tight joint.

The kit is then fastened securely to the air tight membrane using the special tape supplied in the bag, together with the EPDM seal.

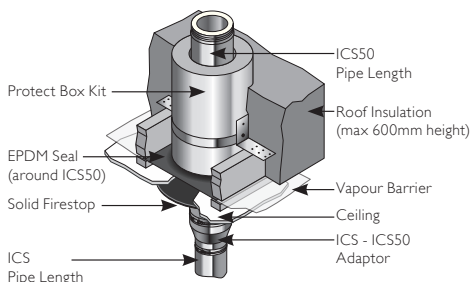

INSTALLATION

Schiedel airtight kits are tailored to meet the outer diameter of Schiedel's twin wall insulated ICS50 System Chimney.

The kit is pulled around the outer case of the ICS50 System Chimney and attached to the air tight membrane, using the special tape provided.

APPLICATION

The tape is used to attach the EPDM seal to the vapour and/or wind barriers. Schiedel Chimney Systems Ltd does not advise using the tape on rough surfaces, concrete, brick or bitumen-based materials. Surfaces must be clean, dry and grease-free before fitting.

SEALING TAPE

The special tape used with the airtight kit is made from elastic PE film and acryl adhesive. This combination means the tape is long-lasting and quick to fit (it sticks immediately). To make it as easy to use as possible, the tape comes with a paper liner which is removed prior to use.

N.B. Do not use tape on steel pipe, only to seal the joint between the EPDM seal and the vapour/wind barriers.

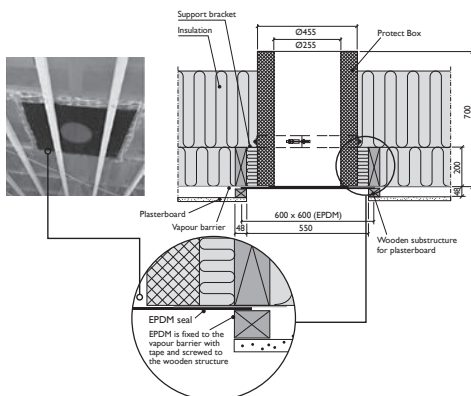

Support Components

ROOF SUPPORT

The roof support is supplied as a kit complete with two side plates for fixing to the roof trusses, a band to give lateral support to the chimney as it passes through the roof, and self tapping screws, which are secured to the chimney through the band give a load bearing capacity. When the plates are installed above the roof trusses as in Fig.1 the maximum number of pipes, which may be suspended from the roof support is 6 x 1m pipes. When the plates are attached below the trusses as in Fig.2 the maximum number of pipes, which may be suspended is 4 x 1m pipes.

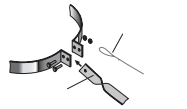
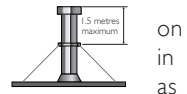
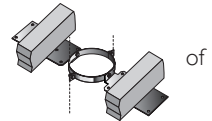
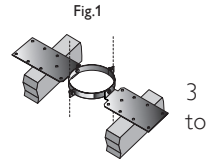

Guy Wire Bracket a the

1. The band should be lowered down over the top of the ICS pipe, and positioned so that the the side plates are resting top of the roof trusses as in Fig.1 or below the roof trusses the case of Fig. 2. The recommended position is always per Fig.1 where circumstances allow this solution.
2. The band should then be tightened using the nut and bolt provided.
3. Using the holes pre-drilled in the roof support band, drill 3mm holes in the outer case of the chimney section (drill bit should be set for depth no greater than 10mm to avoid any damage to the liner of chimney)
4. Use the self tapping screws provided to secure the clamp band to the outer casing of the chimney section.

Please note: It is the responsibility of the installer to ensure that the truss to which the roof support is being attached is load bearing and capable of withstanding the weight of the system being installed.

CEILING HANGER

This accessory is designed to support 'horizontal' runs of the chimney from the roof or ceiling. Please note that when used in combination with a condensing appliance, this 'horizontal' section must have a fall of minimum 3° on it to allow for condensate to drain back to a suitable drain point and to avoid pooling of condensate, which would damage the gaskets. Schiedel provides the split band and the installer will provide the screwed rod and fittings.



Ceiling Hanger

1. Position the split band around the chimney section and fasten using the nuts and bolts provided. The second bolt hole on the arms of the band is to allow for connection of the screwed rod, which will be provided by the installer.
2. Maximum support spacing for the ceiling hanger is to be no more than 1.5 metres between centres.

Support Components

GUY WIRE BRACKET

This component should be used to secure unsupported chimney sections above roof level. Guy wires or preferably rigid stays (supplied by others) must be fixed to the bracket and secured to suitable anchorage points to ensure that the chimney sections are stable.

A maximum chimney height of 1.5 metres from the last support, or from the roof is permitted. Additional height requirements MUST be supported at 1.5 metre intervals using the guy wire bracket as specified above, or by using telescopic roof stays.

TELESCOPIC ROOF STAYS

The telescopic roof stay kit has been added to the range to allow for extra support on chimneys above roof level, where standard guy wires can not be fitted. The telescopic legs allow for height adjustment from 1.6m-2.5m

CEILING HANGER

This accessory is designed to support horizontal runs of the chimney from the roof or ceiling and offers adjustment from 130mm to 1115mm.

1. Once the position of the ceiling support has been determined, the section length of uni-rax channel must be securely fixed to the roof or the ceiling using a method of attachment to ensure adequate attachment and support.
2. All items are assembled as shown to attach the length of studding to the channel.
3. Attach the stud connector to the length of studding and connect the eye bolt to the connector.
4. Position the split band around the chimney section and secure to the eye bolt using the nut/ bolt provided.
5. Maximum support spacing to be no more than 1.5 metres.

Telescopic Roof Stays

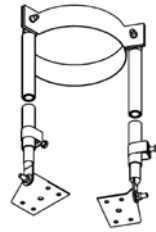

Support Components

WALL SLEEVE (90° & 135° VARIANTS)

Wall sleeves must be used to protect the building where the chimney passes through a wall (see Fig. 2 & 3). The 90° version is supplied as a straight length whereas the 135° version is mitred at 45 degrees on one end. The sleeve should be cut down to the correct length on site to fit flush with the wall (see Fig. 1 & 2). The sleeve should be adequately weatherproofed, using a good quality building mastic and rope fibre.

TWO PIECE TRIM COLLAR (90° & 135° VARIANTS)

Two piece trim collars are fitted around the ICS pipe where it protrudes through both the inside and the outside of the wall (see Fig. 1 & 2). They should be fastened to the wall using an adequate method of fixing. The trim collars should be adequately weatherproofed back to the wall and around the chimney, using a good quality building mastic or equivalent.

ANGLED FLASHING

Manufactured in sheet aluminium for use on pitched roofs. The base of the flashing should be nailed or screw fixed to the roof batons prior to tiling. The front edge of the flashing should be hooked to the underside of the batons to prevent lifting. This component should be sealed with the mastic sealant provided and **MUST** be used in conjunction with the storm collar supplied.

FLAT FLASHING

Manufactured in sheet aluminium for use on flat roofs the base of the flashing should be covered by the roofing felt and then sealed. This component should be sealed with the mastic sealant provided and **MUST** be used in conjunction with the storm collar supplied.

STORM COLLAR

The storm collar should be sealed to the outer casing of the flue immediately above the flashing with the mastic sealant provided.

UNIFLASH

This item, which is manufactured with a malleable base and a silicone cone is used to provide a water tight flashing around the chimney as it passes through a roof pitched between 0-45 degrees. The cone is marked with pipe diameter sizes. 1. Cut the cone to suit the correct diameter of chimney. 2. Slide the flashing down over the top of the pipe and then form the base to the shape of the roof surface. 3. Seal as required.

Ext Ø	80-200	150-300	250-450
A	500	685	800

TERMINALS

Terminals are supplied complete with a locking band. Once the terminal has been pushed into place, the adjustment bolt on the locking band clip should be tightened to ensure that the terminal is properly secured to the previous pipe.

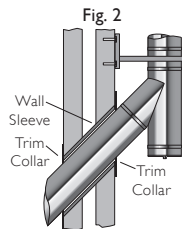
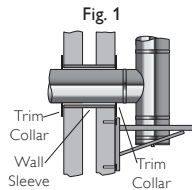

Storm Collar

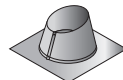

Flat Flashing



Storm Collar

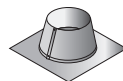

Angled Flashing

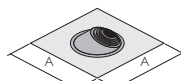

Uniflash

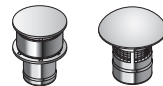

Anti Splash Terminal

Raincap



Tapered Terminal

System Design

OUTLET SITING

Flue terminations for solid fuel & oil are subject to EN15287-1 2007. Figures A and B illustrate recommendations for the most commonly encountered outlet terminations. Flue terminations for gas in domestic situations are governed by the BS5440-1 2008 Section 4.2. Figure C illustrates recommendations for the most common siting situations encountered. Adjacent taller structures may require increased height. The minimum flue projection through the roof is 600mm to the underside of the terminal.

FLUE ROUTING

The chimney should remain as straight as possible through its vertical run to assist flow. Should it be necessary to offset a chimney run the following guidelines should be adhered to:

It is recommended that a vertical rise of 600mm should be allowed immediately above the appliance before any change of direction.

Within a system, on all fuels, there should be no more than 4 changes of direction of maximum 45°.

90° Factory made bends or tees within the system may be treated as being equal to two 45° bends (see Document J of the Building Regulations issued October 1st 2010).

TERMINAL TYPES

On solid fuel appliances, an open termination is normally recommended. However in certain conditions, rain caps or anti-downdraught terminals may be used.

Rain caps and anti-downdraught terminals are available in two versions, with mesh/spark guard and without mesh. Where a terminal with mesh is used, there is a risk of soot build up, and therefore regular cleaning is required to avoid blockage, particularly when using oil or solid fuel.

PROVISION FOR SWEEPING, CLEANING AND MAINTENANCE

Provision should be made for inspecting and cleaning the chimney. To aid cleaning, sufficient distance should be left between changes of direction to permit the safe passage of cleaning brushes within the system. This is particularly important on solid fuel applications. It is recommended that chimneys serving solid fuel appliances be swept as frequently as necessary but at least twice a year. Choose an access component suitable for your installation unless cleaning/inspection can be done through the appliance.

System Design

OUTLET SITING FOR OIL APPLIANCES (<45KW)

Location of outlet		Pressure Jet Burner	Vapourising Burner
M	Above the highest point of an intersection with the roof	600mm	1000mm
N	From a structure to the side of the terminal	750mm	2300mm
O	Above a vertical structure which is less than 750mm (pressure jet burner) or 2300mm (vapourising burner) horizontally from the side of the terminal	600mm	1000mm
P	From a ridge terminal to a vertical structure on the roof	1500mm	Should not be used

OUTLET SITING FOR SOLID FUEL APPLIANCES (<50KW)

Point where flue passes through weather surface (Notes 1, 2)		Clearance to flue outlet
A	At or within 600mm of the ridge	At or within 600mm above the ridge
B	Elsewhere on the roof (whether pitched or flat)	At least 2300mm horizontally from the nearest point on the weather surface and: a) at least 1000mm above the highest point of intersection of the chimney and the weather surface; or b) at least as high as the ridge
C	Below (on a pitched roof) or within 2300mm horizontally to an openable rooflight, dormer window or other opening (Note 3)	At least 1000mm above the top of the opening
D	Within 2300mm of an adjoining or adjacent building, whether or not beyond the boundary (Note 3)	At least 600mm above any part of the adjacent building within 2300mm

LOCATION OF OUTLET

Fig. A
Outlet siting for Oil Appliances (<45kW)

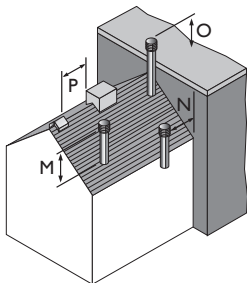
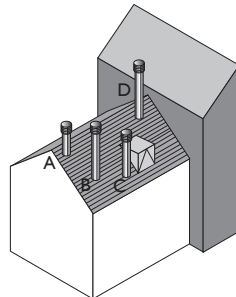

Fig. B
Outlet siting for Solid Fuel Appliances (<50kW)



System Design

1. The weather surface is the building external surface, such as its roof, tiles or external walls.
2. A flat roof has a pitch less than 10°.
3. The clearance for A or B, as appropriate, will also apply.
4. A vertical flue fixed to an outside wall should be treated as equivalent to an inside flue emerging at the nearest edge of the roof.

Fig. C
BS 5440-1 Outlet siting for
Gas Appliances (<70kW)

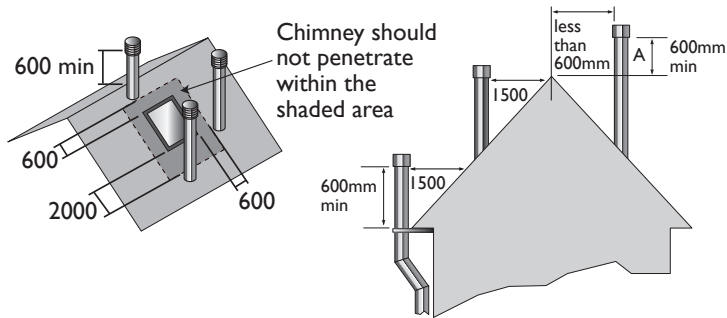

ROOM VENTILATION

The room carrying the appliance should have an air vent either direct to an external air source or vented into a room that has an external vent direct to an air source. This is required to provide adequate air supply to allow the appliance and flue to operate efficiently. These requirements are specified in the Building Regulations (Document J) also by CIBSE and BS5440.

COMMERCIAL INSTALLATIONS

Schiedel can provide a full design & flue sizing advice service for commercial installations, using both ICID Plus and our ICS product ranges.

PROVISION FOR CONDENSATE DISPOSAL (subject to appliance manufacturer recommendations)

Normally solid fuel and atmospheric gas and oil appliances will not need a drain unless rain ingress is significant. Most condensing appliances however need provision for drainage. As a rule of thumb a condensing boiler produces 1 to 1.5 litres of condensate per hour per 10kW of input.

This is a significant amount of acidic liquid which must be drained from the system. Choose appropriate flue drainage components, normally fitted at the base of the stack and close to the appliance outlet.

On high efficiency or on condensing systems, a 3° slope on horizontal runs is advised, using the appropriate 87° bend and 93° tee.

Typical External Installations

Floor Mounted Installation with Base Drain Section

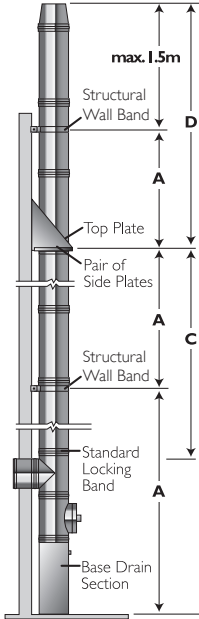

Wall Mounted Installation with pair of Cantilever Brackets and Structural Locking Bands

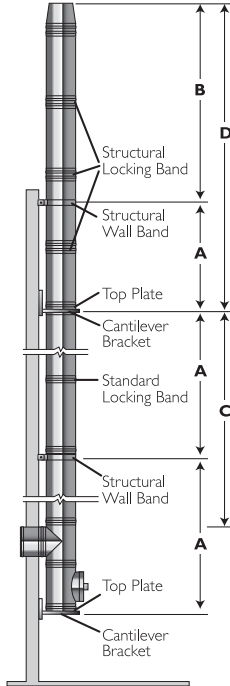

Offset Installation (45°) with pair of Side Plates

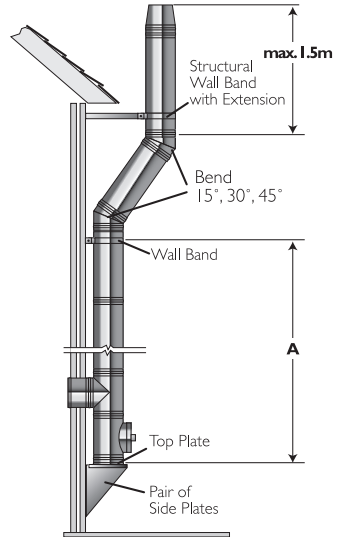

Max Offset Info (in same plane)

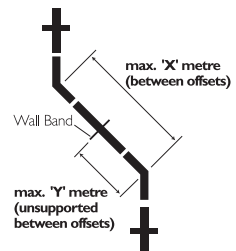

Distance between Lateral Supports									
Int Ø mm	80	100	130	150	180	200	230	250	300
A (m)	4	4	4	4	4	4	4	4	4
B (m)	3	3	3	3	3	3	3	3	25
C (m)	15	15	15	15	15	15	15	15	15
D (m)	15	15	15	15	15	15	15	15	15

Int Ø	80-300
X (m)	3
Y (m)	1.5

Load Bearing Data

Maximum Load Bearing (metres of pipe)			
Internal Diameter (mm)	80-130	150-180	200-300
Base Drain Section	22	18	18
Telescopic Floor Support	18	18	18
Retrofit Wall Support	10	10*	
Adjustable Top Plate + Locking Band	15	15	15
Pair of Side Plates (see Diagram A)	15	15	15
Pair of Side Plates (see Diagram B)	10	10	10
Cantilever Support	22	18	18
Extension Support (Anchor Plate)	1.5	1.5	1.5
Ventilated Support Plate (All types)	12	12	9
Support Plate	12	12	9
Ceiling Hanger	1.5	1.5	1.5
Wall Band 50/60mm	3	3	3
Adjustable Wall Band 60-300mm	3	3	3
Structural Wall Band	4	4	4
Extension for Structural Wall Band	4	4	4
Guy Wire Bracket	1.5	1.5	1.5
Roof Support above truss (see Fig. 1 p.19)	6	6	6
Roof Support - below truss (see Fig. 2 p.19)	4	4	4
90° Tee + Locking Band	22	18	18
93° Tee + Locking Band	22	18	18
135° Tee + Locking Band	15	10	10
Inspection Tee (Round)	22	18	18

* Retrofit Wall Support available diameters 80 - 150 only

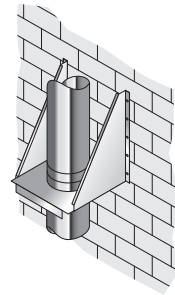

Diagram A

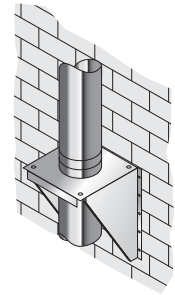

Diagram B

Component Weights

Approximate Weights of Finished Goods (Kg)					
Internal Diameter Length(mm)	1000	750	500	250	195
80	4.32	-	2.13	1.09	0.85
100	5.14	-	2.53	1.29	1.01
130	6.35	4.74	3.14	1.60	1.24
150	7.18	5.36	3.54	1.86	1.41
180	8.40	-	4.14	2.11	1.65
200	9.22	-	4.55	2.31	1.80
230	10.44	-	5.13	2.62	2.03
250	11.24	-	5.53	2.81	2.19
300	12.08	-	5.97	2.92	2.29

After Installation

TESTING AND COMMISSIONING PRIOR TO FIRST USE

This is carried out using a flue flow test as described in BS EN 15287 Parts 1 & 2, with reference to the appropriate appliance type.

APPLIANCE OPERATION

If the appliance is slumbered overnight or for longer periods then it is advisable to run the appliance at controlled high fire condition for a period of at least 30 minutes. Prolonged slumbering of the appliance is a contributing factor to a system chimney failure. It is important to maintain sufficiently high flue gas temperatures in order to avoid condensate and acid corrosion problems, and to ensure complete combustion of the fuel.

MULTI-FUEL APPLICATIONS

Multi-Fuel refers to an appliance which may be used to burn either seasoned wood, or approved solid fuels. These fuels should not be mixed, as this increases the risk of deposits being built up in the liner.

MAINTENANCE

Each chimney must be designed to allow for easy inspection; sweeping should be carried out by competent persons. On solid fuel applications a list of HETAS registered sweeps can be found at www.hetas.co.uk. Chimney flue cleaning and inspection require the use of appropriate tooling – under no circumstances should chemical cleaners or mild steel tools be used to sweep stainless steel chimneys. Mechanical sweeping methods such as Rodtech, Rodstation and Gardus, which have been tested and approved by Schiedel Chimney Systems may be used. Cleaning/inspection of any chimney system should be carried out at least once a year, along with maintenance of the appliance, but it is recommended that chimneys serving solid fuel appliances be swept at least twice a year, at the end of the heating season to remove any deposits, which may have built up during the season, and prior to the start of the next heating season to ensure that the the flue way is clear of any blockages such as birds nests etc.

We would advise that monthly checks are carried out to ensure that there is no build up of any deposits in the flue way of the connecting flue pipe or system chimney.

FUEL STORAGE AND USAGE

Where solid fuels are being used, correct storage is critical and fuels must be kept dry. Wood must be seasoned prior to use, with a maximum moisture content of 20%. Only approved fuels should be used. Refer to HETAS list for details on www.hetas.co.uk. The fuel used must be suitable for the appliance - please refer to manufacturer's instructions.

NOTICE PLATE FOR ICS PRODUCT

The Notice plate should be marked up in indelible ink and securely fixed in an unobtrusive but obvious position within the building such as:

- Next to the electricity consumer unit.
- Next to the chimney installation described.
- Next to the water supply stop-cock.

See example alongside:

IMPORTANT SAFETY INFORMATION
THIS NOTICE PLATE MUST BE MARKED UP OR CHECKED
The Galvan, Greenwell, Sarncliffe 14213 999

INSTALLER ADDRESS	The Galvan, Greenwell, Sarncliffe 14213 999	
FLUE MATERIAL	✓ <input type="checkbox"/> Galvan	<input type="checkbox"/> Steel
APPLIANCE COMBUSTION	<input type="checkbox"/> Solid Fuel	<input checked="" type="checkbox"/> Multi-Fuel
APPLIANCE TYPE	Narrow Flue (H) Wood Burning Stove	
FLUE TYPE	<input type="checkbox"/> Solid Fuel	<input checked="" type="checkbox"/> Multi-Fuel
INSTALLATION DATE	02/03/12	
INSTALLER NAME ADDRESS	14213 999	14213 999
A.N. Other Ltd, Park Street, Washington, NE39 0JQ	14213 999	14213 999
OTHER APPLIANCE	N/A (Leave blank) Chimney swept before installation.	
CHIMNEY SYSTEM REFERENCE	102011612310710	102011612310710
CHIMNEY SYSTEM REFERENCE	102011612310710	102011612310710
CHIMNEY SYSTEM REFERENCE	102011612310710	102011612310710

WARNING! Please ensure that this notice is marked in accordance with the manufacturer's recommendations. It is advised that the system is swept immediately upon completion and the chimney inspected to ensure that the system is working correctly.

Product Guarantee

Under normal operating conditions and providing the system is installed correctly, it should last the lifetime of the appliance, which normally is 10 years. ICS carries a 10 year conditional guarantee. The conditions are that the system is:-

- Correctly sized and installed in accordance with the manufacturer's instructions, current Building Regulations and relevant British and European standards.
- Maintained correctly by a qualified and competent person and maintenance records kept updated for both appliance and system chimney.
- Used in combination with an appliance burning only approved fuels in accordance with Schiedel Chimney Systems and the appliance manufacturer's instructions.
- The product registration form must have been filled in by an appropriately qualified installer (see p.3 for details), and returned to Schiedel Chimney Systems Ltd.

For recommended fuels listings, please refer to the HETAS Guide www.hetas.co.uk

In the event of a fault developing in the product due to defective materials or faulty manufacture Schiedel Chimney Systems undertake to replace the product only.

Schiedel Chimney Systems cannot accept liability nor take any responsibility for the installation, building or redecorating costs or any other consequential losses arising.

If any complaint is found to be a result of faulty installation, non-compliance with or abuse contrary to these conditions, the cost of site investigation is chargeable.

Schiedel Installer Rewards

Exciting news from Schiedel Chimney Systems for Stove and Chimney Installers! Whenever you register an installation with our easy to use, online guarantee registration portal, you will now accrue points based on the number of installations and installation type.



Once you have reached a minimum of 25 points, you can begin to redeem them for £25 Love2Shop vouchers.

So head on over to www.SchiedelRewards.co.uk; register your installations and start earning points!

Useful Guides

THE SCHIEDEL INSTALLATION APP

This handy mobile guide can be used on mobile devices and touchscreen tablets.

It offers a number of very useful guides on all aspects of installing an appliance using Schiedel Chimney Systems, including:

- Quick and straightforward reference for installers.
- Video breakdowns of each stage of the installation process, from connection to the appliance through to termination.
- Highlighting the safety critical areas where the chimney penetrates the floors, ceilings, roof and walls.
- Incorporates frequently asked questions information at each stage of the installation process, in line with building regulations.
- An easy-to-use system for downloading full product information and installation instructions.
- Register your Guarantee in the App.

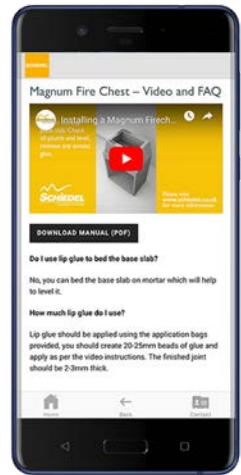

Download the iPhone and iPad version in the App Store and Android version in the Google Play Store.

YOUTUBE TV CHANNEL

The Schiedel YouTube TV Channel contains a number of videos showing installation examples in easy to understand 3D diagrams.

Visit the channel today to learn more
Search for "Schiedel UK" in YouTube to find us.

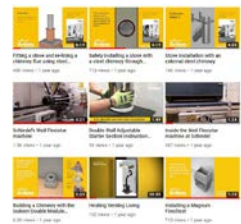

DOWNLOADS SPECIALIST CENTRE

We have a comprehensive range of CAD cells, typical installations using Isokern Pumice components and other diagrams, which are ideal resources for architects and builders when designing a chimney system for a new build or renovation

Visit our website and head over to the SPECIALIST CENTRE which can be found under the SCHIEDEL WORLD menu, or contact us and we will send a USB stick with all the relevant information and downloads on.

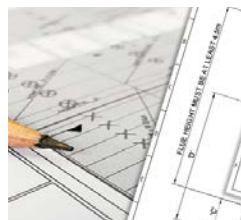

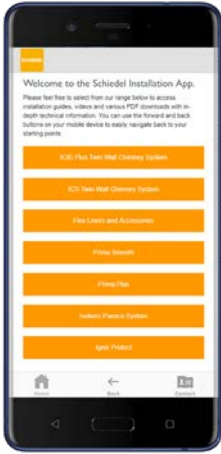

The Schiedel Installation App

Download the app today, as it offers a number of very useful guides on all aspects of installing an appliance using Schiedel Chimney Systems, including:

- Quick and straightforward reference for installers.
- Video breakdowns of each stage of the installation process, from connection to the appliance through to termination.
- Highlighting the safety critical areas where the chimney penetrates the floors, ceilings, roof and walls.
- Incorporates frequently asked questions information at each stage of the installation process, in line with building regulations.
- An easy-to-use system for downloading full product information and installation instructions.
- Register your Guarantee in the App.



Schiedel Installer Rewards

Exciting news from Schiedel Chimney Systems for Stove and Chimney Installers! Whenever you register an installation with our easy to use, online guarantee registration portal, you will now accrue points based on the number of installations and installation type.

Once you have reached a minimum of 25 points, you can begin to redeem them for £25 Love2Shop vouchers.

So head on over to the portal and start to register your installations to take full advantage of our Lifetime Guarantee on Flex and ICID, and also to start earning points!

SCHIEDEL

Schiedel Chimney Systems Ltd.

Crowther Estate

Washington

Tyne & Wear NE38 0AQ

Tel. +44 (0)191 416 1150

sales.uk@schiedel.com | www.schiedel.com/uk

A standard
INDUSTRIES COMPANY