



UE/UED Flue System

Twin wall connecting flue pipe and system chimney with air insulation

SCHIEDEL

System Description

The **UE** system is a modular twin wall flue system, made of stainless steel with an air gap insulation and a sealing ring. **UE** is suitable for low temperatures, condensing and non-condensing applications with flue gasses under positive or negative pressure. The system is suited for a wide range of applications such as condensing heaters and boilers, gas fires and ventilation systems.

Applications

- Gas fires
- Oil-fired appliances
- Industrial ventilation systems
- Air inlet or ventilation systems
- Condensing heaters and boilers
- Atmospheric gas-fired boilers

Advantages

- Compatible with ME and MF
- Pressure-tight up to 5000 Pa
- Inner- and outer wall from high quality stainless steel
- Reduced distance to combustibles

- A.** Maximum height above Tee piece when chimney is supported by wall support at base.
- B.** Maximum height that can be borne by a wall support.
- C.** Maximum distance between lateral supports i.e. wall bands and wall supports.
- D.** Maximum free standing height above last support.
 - For non-vertical parts of the flue system, the maximum distance between two wall bands i.e. brackets is 1,5 m
 - In case of a condensing application a slope of 3° is required on horizontal systems to allow condensate to run off.

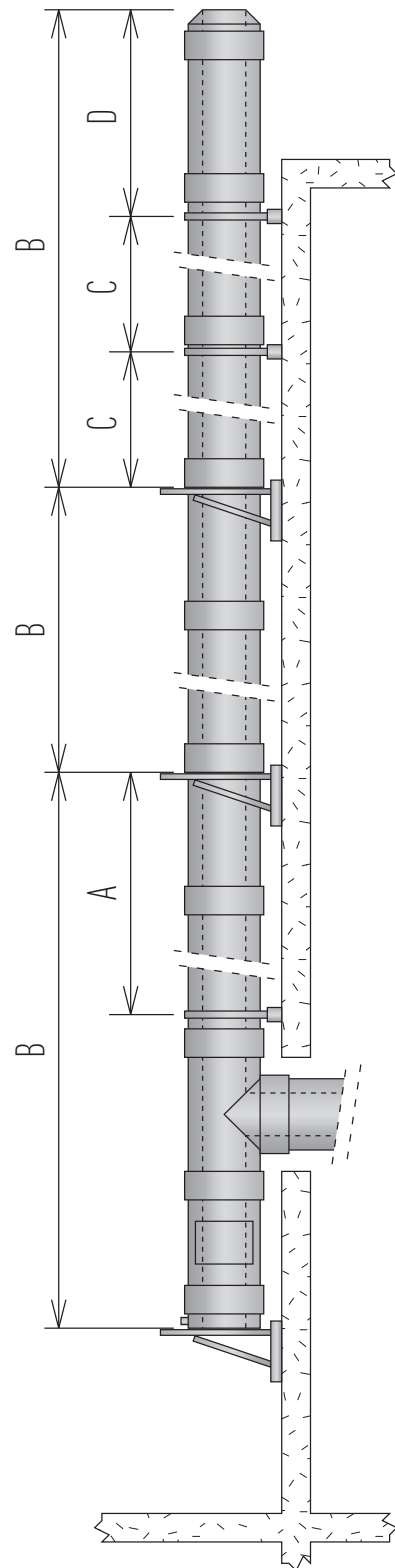

Technical characteristics

Technical characteristics			
Application	System Chimney/Connecting Flue Pipe		
Operating mode	Dry/wet		
Pressure	Negative pressure (N)/positive pressure (P/H)		
Max. working pressure	5000 Pa		
Max. operating temperature	400 °C (N) 200 °C (P/H)		
Soot Fire resistant*	Yes (see G designations below) No (see O designations below)		
Inner wall	material	AISI 316 L (1.4404)	
	thickness	0.4 mm	
Outer wall	material	AISI 304 (1.4301)	
	thickness	0.4 mm	
Insulation	type	Air	
	thickness	7.5 mm	
Fuel type	Gas, oil, wood, coal, pellets		
Seals	Elastomer. Where case flue gas temperatures exceed 200°C, sealants as well as the cap and door seals should be removed before installation)		
CE approved *			
EN 1856-1: T200 P1/H1 W V2 L50040 O25, T250 N1 W V2 L50040 O25, T400 N1 W V2 L50040 O130, T400 N1 D V3 L50040 G130			
EN 1856-2: T200 P1/H1 W V2 L50040 O50 M, T400 N1 W V2 L50040 O200 M, T400 N1 D V3 L50040 G200 M			

Chimney diameter							
Inner diameter (mm)	80	100	130	150	180	200	250
Outer diameter (mm)	95	115	145	165	195	215	265
Cross section (cm ²)	50	79	133	177	254	314	491
Weight (±kg/m)	1,5	2,5	2,5	3,5	4	4	5

Maximum load bearing (metres of pipe)								
Ø (mm)		80	100	130	150	180	200	250
A (m)	UET 87	30	30	30	30	30	30	20
	UETV 08 / UETV 10	30	30	30	30	30	30	20
	UEI	30	30	30	30	30	30	20
B (m)	UEOL	30	30	30	30	30	30	30
	UEMO	30	30	30	30	30	30	30
	UEVS	30	30	30	30	30	30	30
	UEDQ	5	5	5	5	5	5	5
	UEVQ	5	5	5	5	5	5	5
C (m)	UEMB *	2	2	2	2	2	2	2
	UEDQ *	2	2	2	2	2	2	2
	UEVQ *	2	2	2	2	2	2	2
D (m)	UEMB *	1,5	1,5	1,5	1,5	1,5	1,5	1,5
	UEMB + UESK **	2,5	2,5	2,5	2,5	2,5	2,5	2,5
	UEDQ *	1,5	1,5	1,5	1,5	1,5	1,5	1,5
	UEDQ + UESK **	2,5	2,5	2,5	2,5	2,5	2,5	2,5
	UEBT ***	1,5	1,5	1,5	1,5	1,5	1,5	1,5

* Provided that it's installed with a Locking Band (UEKB).

** Provided that the joints above and below the last connection point are reinforced with a Structural Locking Band (UESK).

*** The max construction height B is reduced by 30%, when making use of a guy wire bracket (UEBT). Guy-wires are to be fixed at an angle of 45 degrees, at 2/3 of the freestanding height.

Design Components

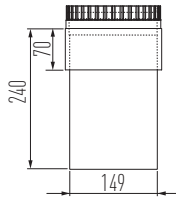

Adaptor Design		Old Code UEDAS
Int Ø A	130	150
SAP Code	170431	163304

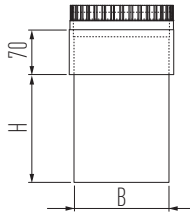

Adaptor, reducing, increasing Design		Old Code UEDAS 00
Int Ø A		150
B		to be specified on order
H		to be specified on order
SAP Code		

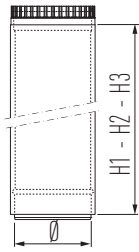

Length Design		Old Code UED 100/50/25
Int Ø A	130	150
H1	960	960
H2	450	450
H3	200	200
D	012	160
SAP Code UED 100	170426	163288
SAP Code UED 50	170427	163296
SAP Code UED 25	170428	163289

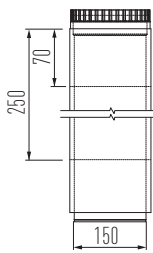

Adjustable length Design (N1 applications only)		Old Code UEDPP
Int Ø	130	150
SAP Code	170429	163334

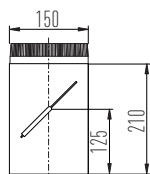

Segment with damper Design (N1 applications only)		Old Code UEDRK
Int Ø		150
SAP Code		163355

Design Components

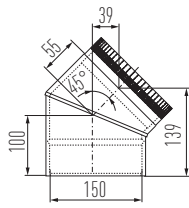

Elbow 45°		Old Code UEDB 45	
∅	130	150	
SAP Code	170430	163305	

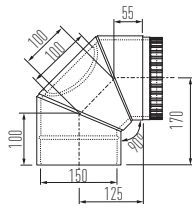

Elbow 90° with Inspection Cover Design, negative pressure		Old Code UEDBI 90	
∅		150	
SAP Code		163319	

Starting Components / Adaptors

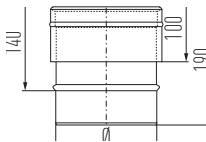

Adaptor ME-UE							Old Code UEA	
∅	80	100	130	150	180	200	250	
SAP Code	163253	163254	163255	163256	163257	163258	163259	

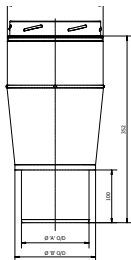

UE to ICID Adjustable starter section		
Int ∅mm	125	150
Ext ∅mm	180	200
A	127.5	152.2
B	147.7	172.2
SAP Code Plain	175405	175406
SAP Code Black	175408	175409

Pipe Lengths

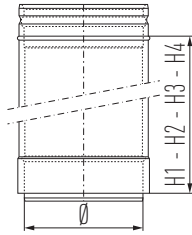

Length		Old Code UE 100/50/25/10						
Ø	80	100	130	150	180	200	250	
H1	960	960	960	960	960	960	960	
H2	460	460	460	460	460	460	460	
H3	210	210	210	210	210	210	210	
H4	110	110	110	110	110	110	110	
SAP Code UE 100	163225	163226	163227	163228	163229	163230	163231	
SAP Code UE 50	163246	163247	163248	163249	163250	163251	163252	
SAP Code UE 25	163239	163240	163241	163242	163243	163244	163245	
SAP Code UE 15	163232	163233	163234	163235	163236	163237	163238	



Seal EPDM			
Temperatures always below 120 degrees			
Ø	100	130	150
SAP Code	160576	160577	160578



Seal VITON		
For oil-containing exhaust gases		
Ø	130	150
SAP Code	900012190	900012191

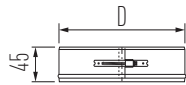

Locking Band		Old Code UEKB						
Ø	80	100	130	150	180	200	250	
D	95	115	145	165	195	215	265	
SAP Code	163392	163393	16394	163395	163396	163397	163398	

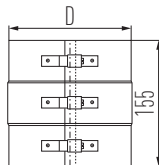

Reinforced Locking Band		Old Code UESK						
Ø	80	100	130	150	180	200	250	
D	95	115	145	165	195	215	265	
SAP Code	163481	163482	163483	163484	163485	163486	163487	

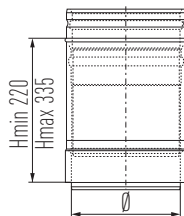

Adjustable Length		Old Code UEPP						
Ø	80	100	130	150	180	200	250	
SAP Code	163444	163445	163446	163447	163448	163449	163450	

Pipe Lengths

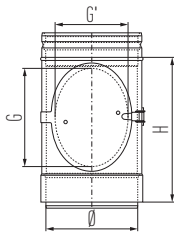

Inspection Length						Old Code UEI	
Ø	80	100	130	150	180	200	250
H	200	200	250	300	300	300	300
G	80	80	140	180	180	180	180
G'	50	50	110	125	125	125	-
SAP Code	163371	163372	163373	163374	163375	163376	163377

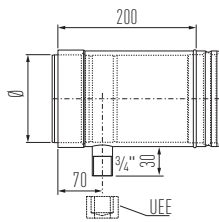

Probe Length and Drain, Horizontal						Old Code UDEM	
Ø	80	100	130	150	180	200	250
SAP Code	163363	163364	163365	163366	163367	163368	163369

Silencers

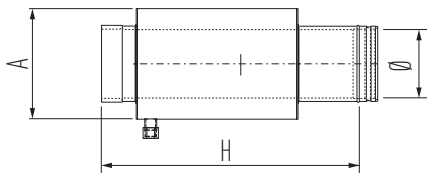

Absorption Silencer						Old Code UESIA	
Ø	80	100	130	150	180	200	250
H	600	600	600	600	780	780	780
A	180	200	230	250	280	300	350
kg	5	6	7	8	11	12	14
SAP Code	163473	163474	163475	163476	163477	163478	163479

Average performance UESI A 80-250

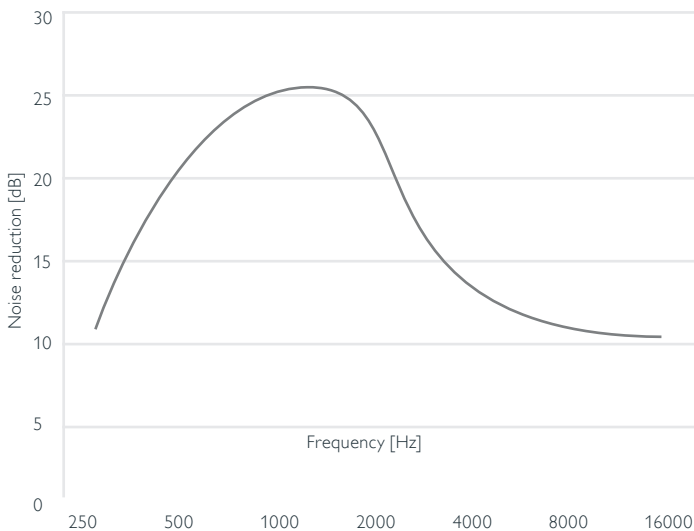

— UESI A

Performance chart is an average measurement over all diameters.
 The insertion loss is measured according to iso 7235: 2003
 The insertion loss can deviate due to temperature or special installation situations.
 Back pressure at a flue gas speed of 5 m/s is approx. 5 Pa
 Back pressure can vary with temperature and gas velocity, please contact Ontop for advice
 For installation MF wallbrackets can be used.

Bends

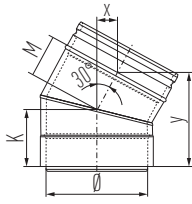

Elbow 30°						Old Code UEB 30	
Ø	80	100	130	150	180	200	250
K	75	80	85	90	95	100	110
M	40	45	50	55	60	65	75
x	20	20	25	25	30	30	35
y	110	120	130	135	145	155	175
SAP Code	163260	163261	163262	163263	163264	163265	163266

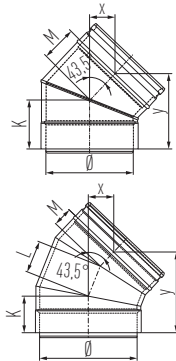

Elbow 43°						Old Code UEB 43	
Ø	80	100	130	150	180	200	250
K	75	80	85	90	95	65	70
L	--	--	--	--	--	65	75
M	40	45	50	55	60	40	45
x	25	30	35	40	40	50	60
y	105	110	120	130	140	155	170
SAP Code	163267	163268	163269	163270	163271	163272	163273

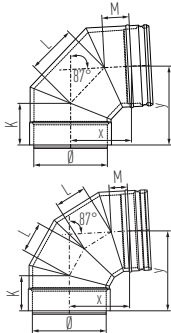

Elbow 87°						Old Code UEB 87	
Ø	80	100	130	150	180	200	250
K	75	80	85	85	85	85	95
L	75	80	90	60	75	80	95
M	40	45	50	50	50	50	60
x	90	100	110	110	150	155	185
y	130	140	150	170	190	200	230
SAP Code	163274	163275	163276	163277	163278	163279	163280

Tees

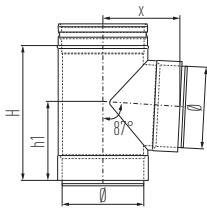

Tee-piece 87°						Old Code UET 87	
Ø	80	100	130	150	180	200	250
H	200	200	250	250	300	300	350
h1	120	120	145	145	170	170	195
x	105	115	130	140	155	165	190
SAP Code	163488	163489	163490	163491	163492	163493	163494

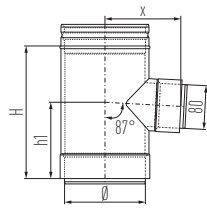

Tee-piece 87°, reducing						Old Code UETV 08	
Ø	100	130	150	180	200	250	
H	200	250	250	250	250	250	
h1	120	140	140	140	140	140	
x	120	135	145	160	170	195	
SAP Code	163502	163503	163504	163505	163506	163507	

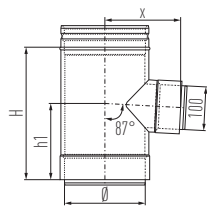

Tee-piece 87°, reducing						Old Code UETV 10	
Ø			130				150
H			250				250
h1			140				140
x			135				145
SAP Code			163508				163509

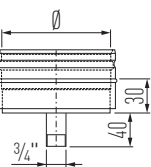

Condensate Drain						Old Code UEKA	
Ø	80	100	130	150	180	200	250
SAP Code	163385	163386	163387	163388	163389	163390	163391

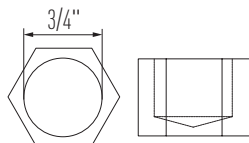

Cap						Old Code UEE 0304	
SAP Code							163691

Support Components

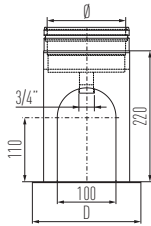

Base Support with Drain					Old Code UEVS	
Ø	130	150	180	200	250	
D	187	207	237	257	307	
SAP Code	163517	163518	163519	163520	163521	

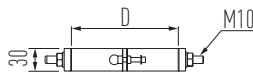

Band for Wall Support					Old Code UEMO		
Ø	80	100	130	150	180	200	250
D	95	115	145	165	195	215	265
SAP Code	163437	163438	163439	163440	163441	163442	163443



Side Plates (Pair) for UEMO (50-90mm)					Old Code UEOL 1		
Ø	80	100	130	150	180	200	250
A	170	185	220	220	220	285	285
B	140	155	190	190	190	255	255
C	90	105	125	125	125	130	130
H	125	140	170	170	170	230	230
SAP Code	165038	165039	165040	165041	165042	165043	165044

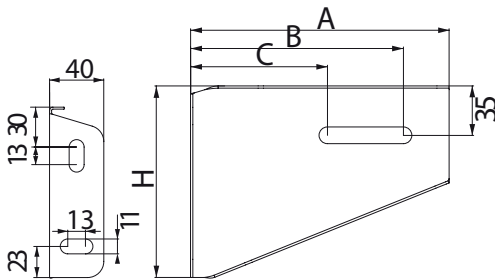

Side Plates (Pair) for UEMO (90-200mm)					Old Code UEOL 2		
Ø	80	100	130	150	180	200	250
A	285	295	315	315	335	345	370
B	255	265	285	285	305	315	340
C	130	145	165	165	180	200	215
H	230	235	255	255	275	285	305
SAP Code	165045	165046	165047	165048	165049	165050	165051

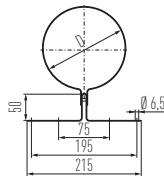

Mounting Band					Old Code UEEB		
Ø	80	100	130	150	180	200	250
D	95	115	145	165	195	215	265
SAP Code	163356	163357	163358	163359	163360	163361	163362

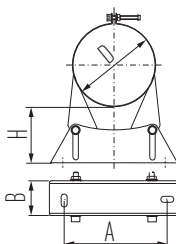

Wall Band Adjustable					Old Code UEMB		
Ø	80	100	130	150	180	200	250
D	95	115	145	165	195	215	265
A	115	115	115	160	160	160	160
B	35	35	35	55	55	55	55
H	25-50	25-50	25-50	50-90	50-90	50-90	50-90
SAP Code	163420	163421	163422	163423	163424	163425	163426

Support Components

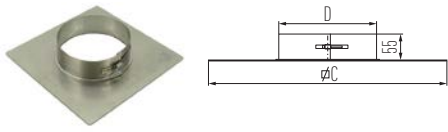

Ceiling Support						Old Code UEVQ	
Ø	80	100	130	150	180	200	250
D	95	115	145	165	195	215	265
C	250	250	300	300	400	400	400
SAP Code	163510	163511	163512	163513	163514	163515	163516

*For use on low temperature applications only (<80 deg. C)

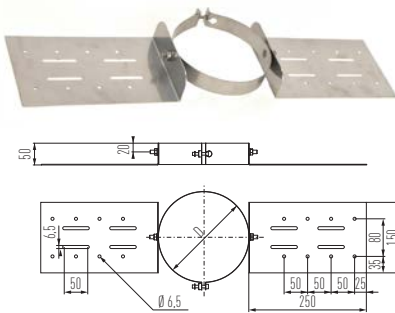

Roof Support						Old Code UEDQ	
Ø	80	100	130	150	180	200	250
D	95	115	145	165	195	215	265
SAP Code	163341	163342	163343	163344	163345	163346	163347

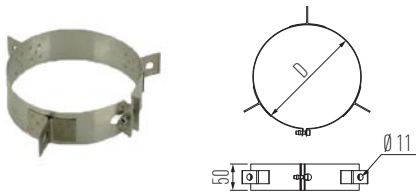

Guy-wire Band					Old Code UEBT	
Ø	130	150	180	200	250	
D	145	165	195	215	265	
SAP Code	165026	165027	165028	165029	165030	

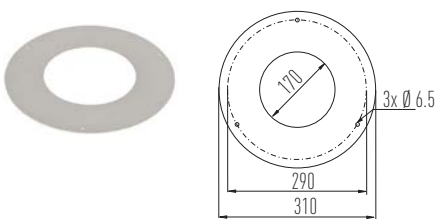

Rosette smooth		Old Code UEDR	
Ø	130	150	
SAP Code	171361	163348	

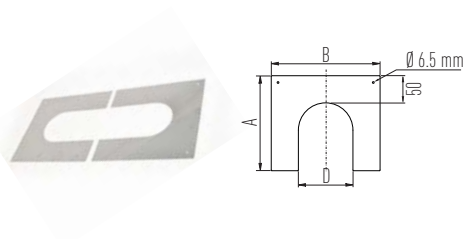

Cover Plates (pair)						Old Code UECP	
Ø	80	100	130	150	180	200	250
A	250	260	280	370	390	420	465
B	295	315	345	365	395	415	465
D	95	115	145	165	195	215	265
SAP Code	163281	163282	163283	163284	163285	163286	163287

*Low temperature applications only.

Flashings

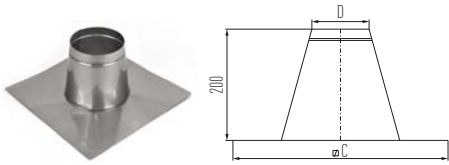

Flat Roof Flashing						Old Code UEDP	
Ø	80	100	130	150	180	200	250
D	105	125	155	175	205	225	275
C	385	405	435	455	485	505	555
SAP Code	163327	163328	163329	163330	163331	163332	163333

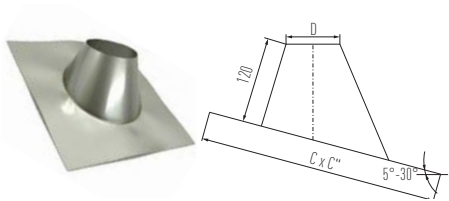

Slope Roof Flashing 5°- 30°						Old Code UEDH	
Ø	80	100	130	150	180	200	250
D	105	125	155	175	205	225	275
C	465	490	525	550	585	610	665
C"	455	475	510	530	565	590	645
SAP Code	163320	163321	163322	163323	163324	163325	163326

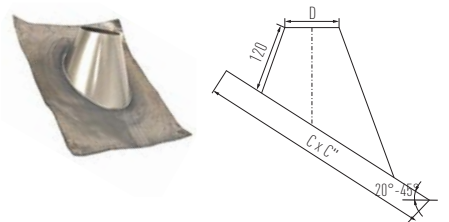

Lead Slope Roof Flashing 20°- 45°						Old Code UELS	
Ø	80	100	130	150	180	200	250
D	105	125	155	175	205	225	275
C	600	600	600	600	600	600	750
C"	750	750	750	750	750	750	1000
SAP Code	163339	163340	163341	163342	163343	163344	163345

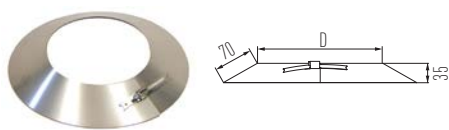

Storm Collar						Old Code UES	
Ø	80	100	130	150	180	200	250
D	95	115	145	165	195	215	265
SAP Code	163466	163467	163468	163469	163470	163471	163472

Terminals

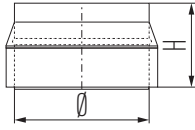

Top Stub						Old Code UEMA	
Ø	80	100	130	150	180	200	250
H	95	100	100	100	100	100	100
SAP Code	163413	163414	163415	163416	163417	163418	163419

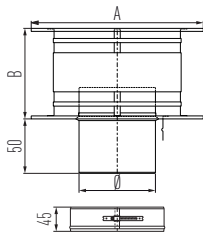

All Weather Cap						Old Code UEK	
Ø	80	100	130	150	180	200	250
A	175	220	285	330	395	440	550
B	90	110	145	165	200	220	275
SAP Code	163378	163379	163380	163381	163382	163383	163384

Typical Installation

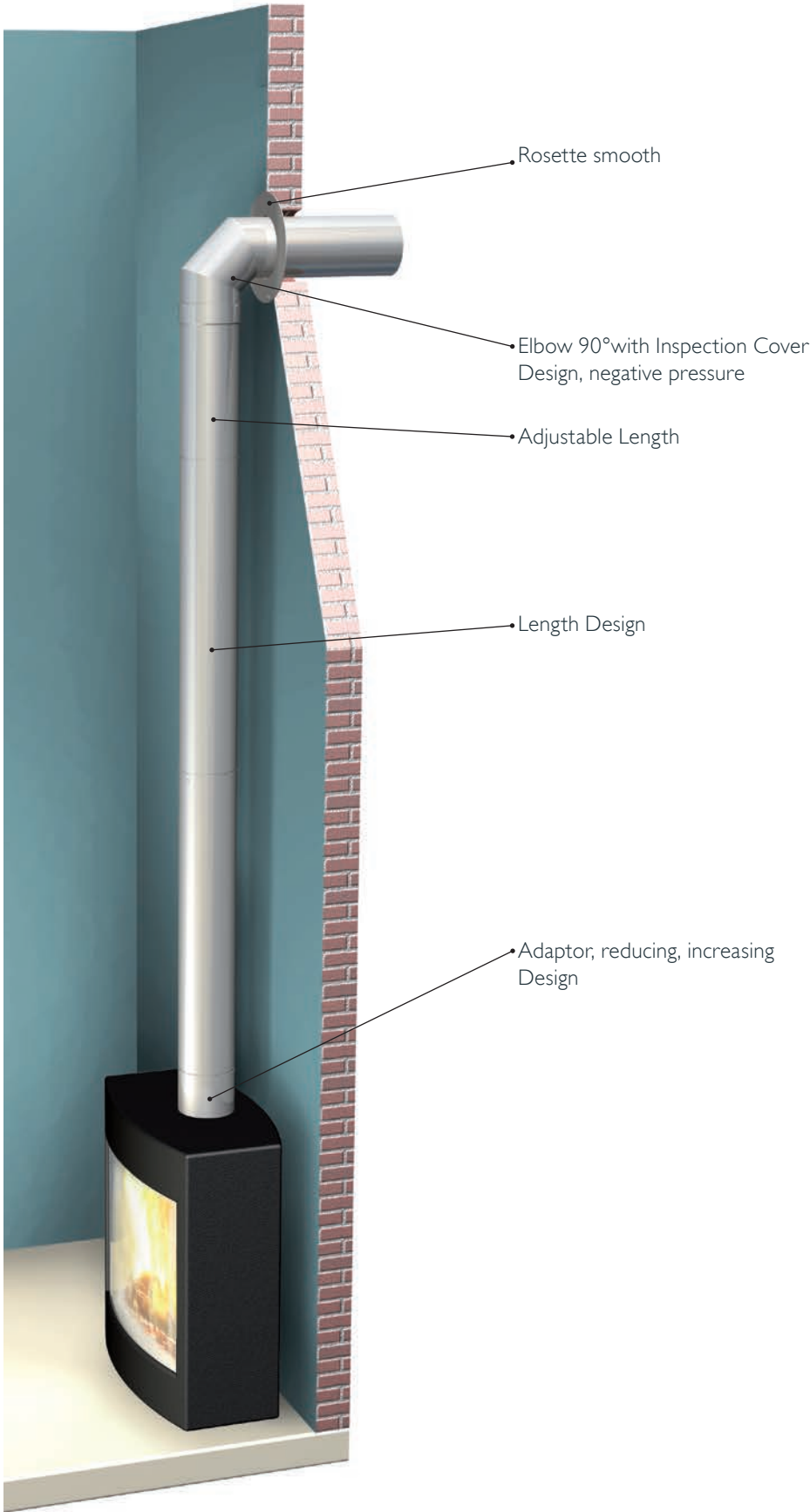

Typical Installation

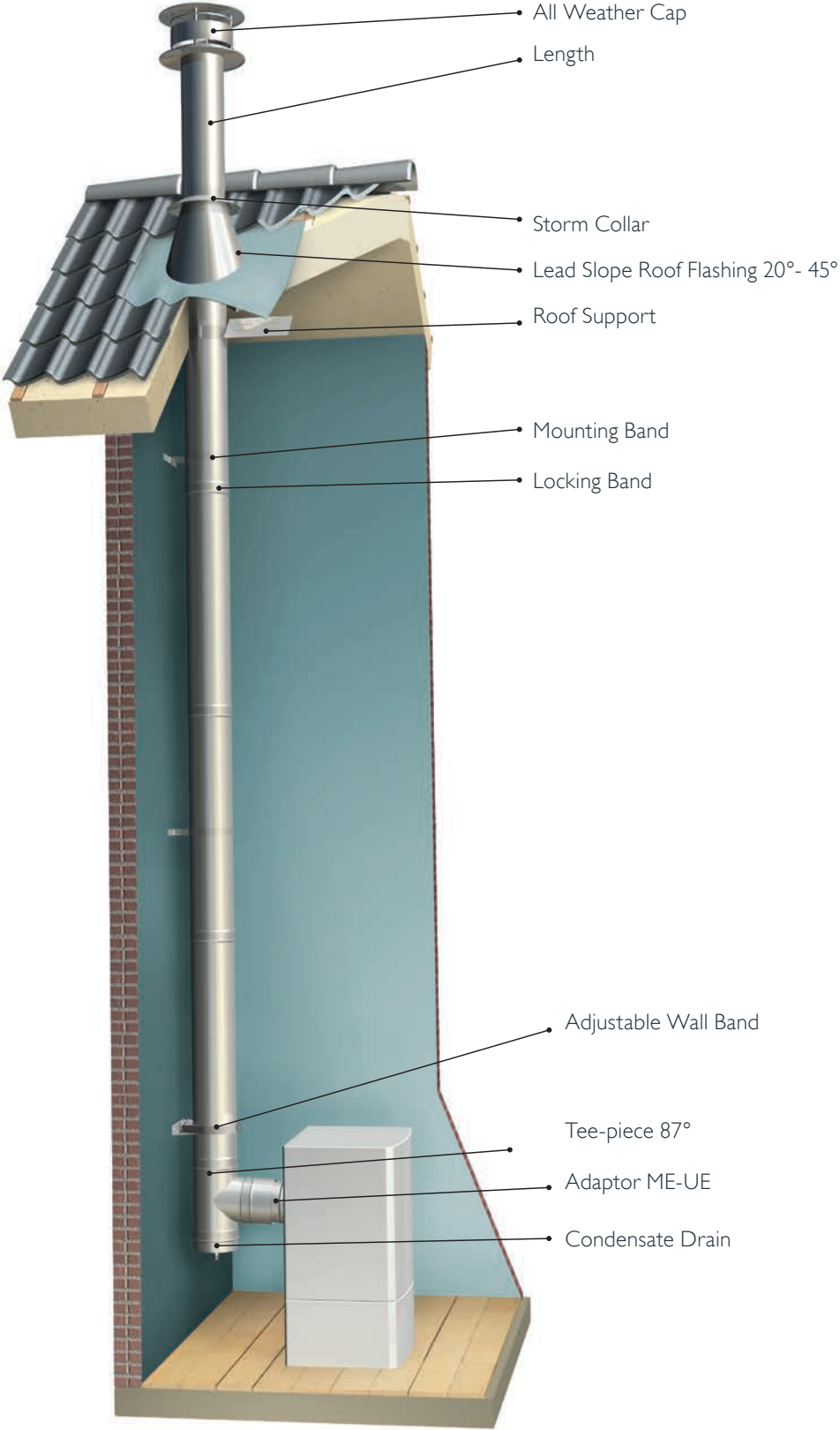



Schiedel Chimney Systems
Crowther Estate
Washington
Tyne & Wear NE38 0AQ
Tel. +44 (0)191 416 1150
Fax. +44 (0)191 415 1263

sales.uk@schiedel.com

Follow us on Social Media @SchiedelUK



A **stañdard**
INDUSTRIES COMPANY